

Presentation

Part Number: WM 260.113

2 x 300 mm swivelling Horizontal Medical Arm for monitoring Philips Intellivue Séries (light applications up to 8 Kg), Vertical Din rail mounting.

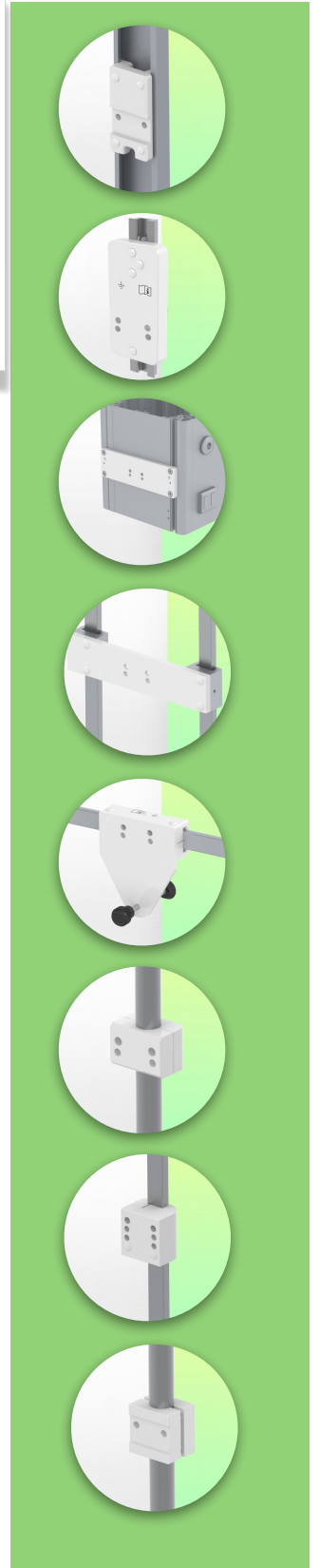
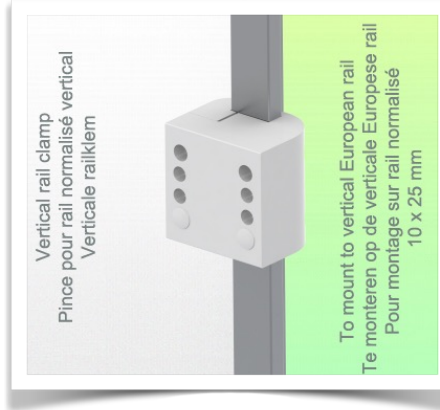
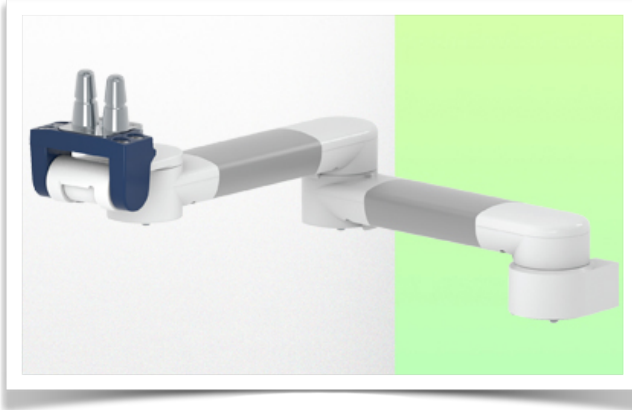

2 x 300 mm swivelling Horizontal Medical Arm for monitoring Philips Intellivue Séries (light applications up to 8 Kg), Vertical Din rail mounting.

This dual 591 mm Vertical Arm allows the monitor to be fixed, oriented and adjusted perfectly. It is coated with an anti-microbial agent for hygiene and cleaning down to the smallest detail. Its modern design has been specially developed for healthcare environments.

Technical specifications:

- * Integral cable management
- * Lightweight application
- * Mounted on Din rail Vertical Universal clamp included (10 x 25 mm, 8 x 35 mm, 10 x 30 mm, 10 x 50 mm)
- * This medical arm simply attaches to the Din rail Horizontal and then adjusts to the rail and clamped with the two grips. There is no height adjustment.
- * The head of this arm complies with the mounting standard for Philips Intellivue series weighing up to 8 kg.
- * Monitor tilt: 20° down and 12° up
- * Monitor rotation: 115° right, 115° left.
- * Arm rotation: 105° right, 105° left.
- * Total length 591 mm
- * Colour RAL 5013 cobalt blue and RAL 9016 traffic white
- * Warranty: 5 years

Technical specifications

Part Number: WM 260.113

2 x 300 mm swivelling Horizontal Medical Arm for monitoring Philips Intellivue Séries (light applications up to 8 Kg), Vertical Din rail mounting.

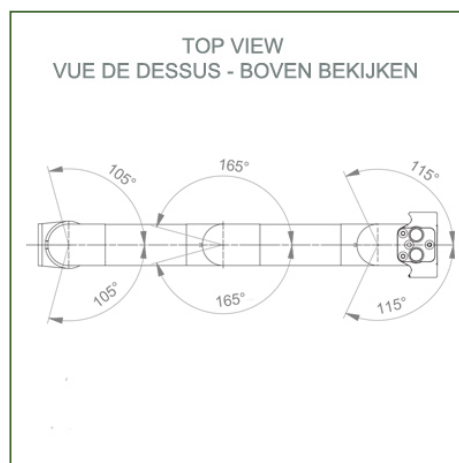
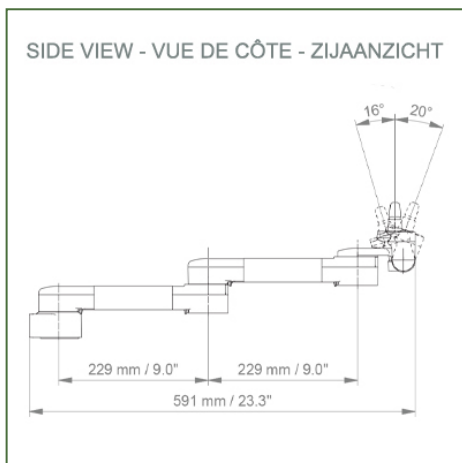
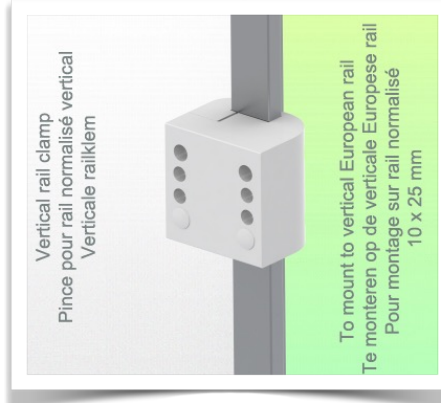
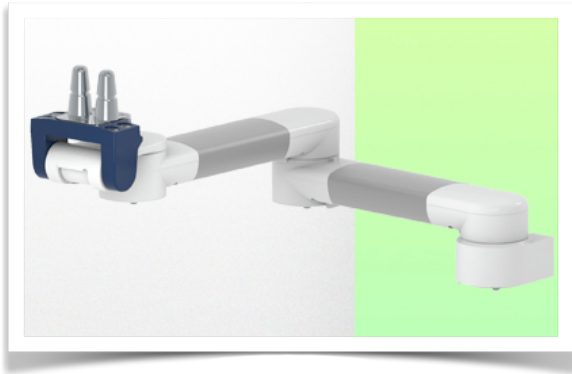

Monitor fitting: Philips Intellivue series
Colour: Decorative parts: RAL 5013 cobalt blue
 Aluminium parts: RAL 9016 traffic white
Max. load capacity of support arm: 8 kg
Monitor fitting max. load: 8 Kg
Product weight: 2,8 Kg

Product strengths:

Non-height-adjustable arm. Swivel arms and extended swivel arms offer full cable integration and easy cleaning for infection control in all critical care areas of the clinical environment. Our 5-year guarantee ensures reliable, trouble-free and maintenance-free operation. The swivel function at the point of attachment and the tilt and swivel function of the monitor adaptation provide optimum positioning of your unit. The extended swivel arm is a two-part arm with a central pivot point between the two arm sections. All bottom-mounted monitors have the safety feature of a 20° tilt stop.

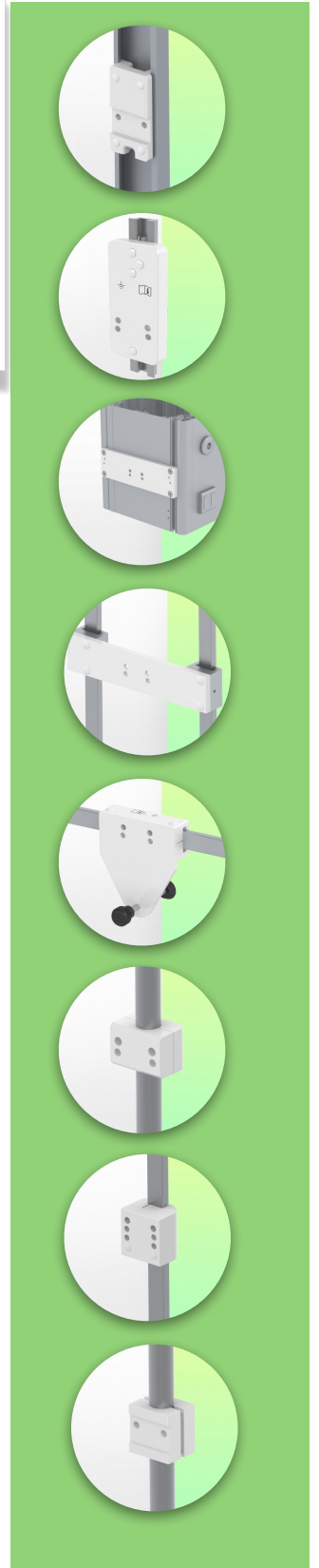

Installation information - Din Rail Vertical standard

Part Number: WM 260.113

2 x 300 mm swivelling Horizontal Medical Arm for monitoring Philips Intellivue Séries (light applications up to 8 Kg), Vertical Din rail

Din Vertical Rail:

Fixed clamp for standard rail For mounting on a vertical standard rail 10 x 25 mm

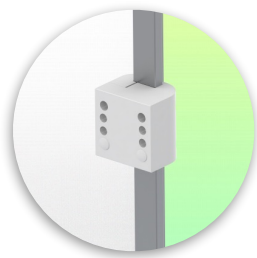
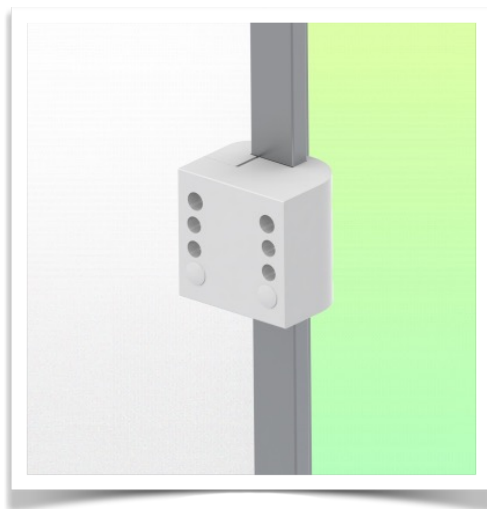
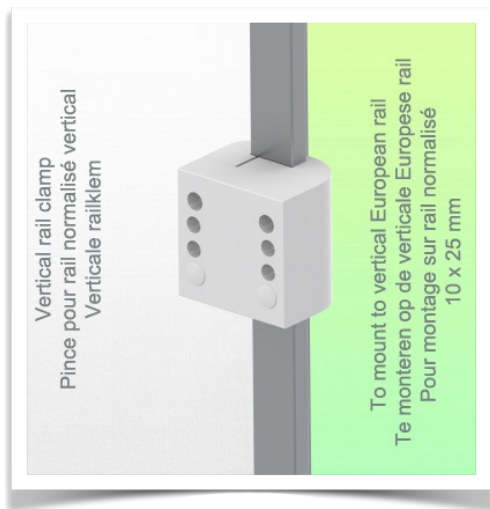

Presentation

Part Number: WM 260.113

2 x 300 mm swivelling Horizontal Medical Arm for monitoring Philips Intellivue Séries (light applications up to 8 Kg), Vertical Din rail mounting.

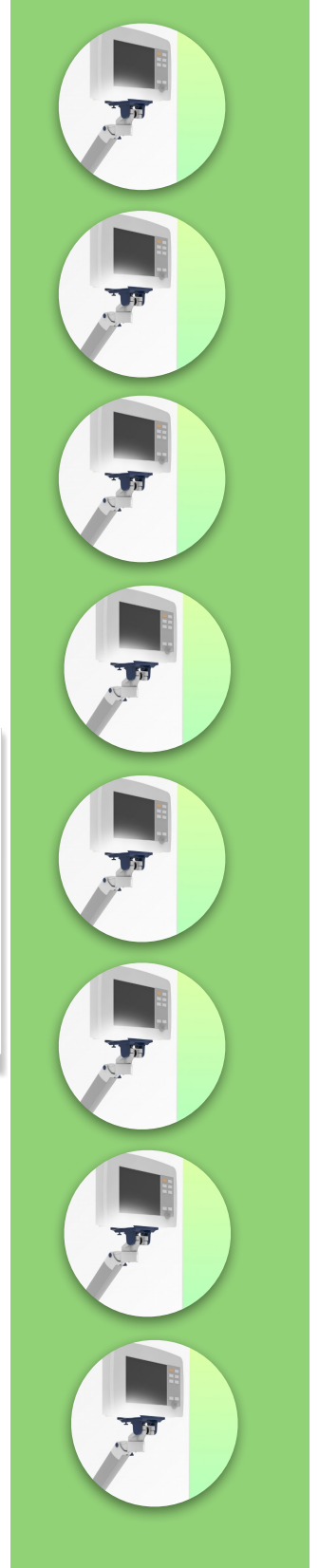
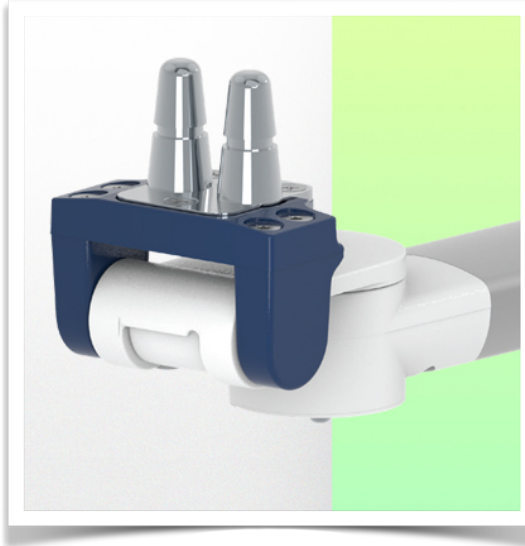
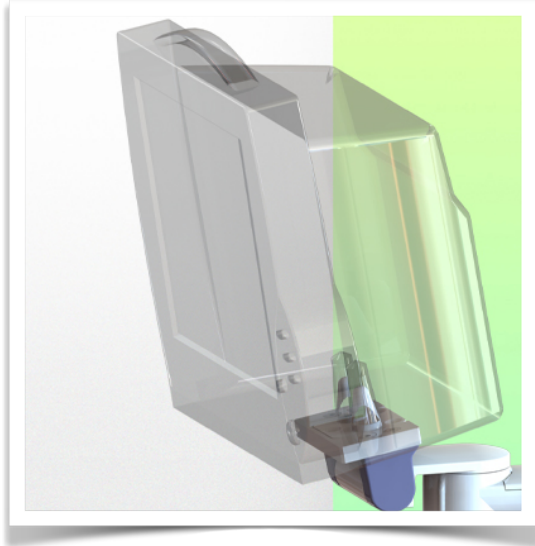

Adaptation monitoring Philips Intellivue series

All our medical arms can be fitted with this adaptation, some illustrations of which can be found here.

