

Presentation

Part Number: WM 260.140X

Height-adjustable medical arm, length 450 mm, for monitoring Philips Intellivue MP2/X2/X3 Séries, table column mounting. Supported weight balancing range from 0 to 3,5 Kg. mounting without power cable hook



Cette colonne possède deux rails de fixation pour les différents éléments qui y seront fixés. (1 rail à l'avant de la colonne, 1 rail à l'arrière)

This column has two fixing rails for the different elements that will be fixed to it (1 rail at the front of the column, 1 rail at the back)

Deze zuil heeft twee bevestigingsrails voor de verschillende elementen die eraan bevestigd zullen worden (1 rail aan de voorkant van de zuil, 1 rail aan de achterkant)

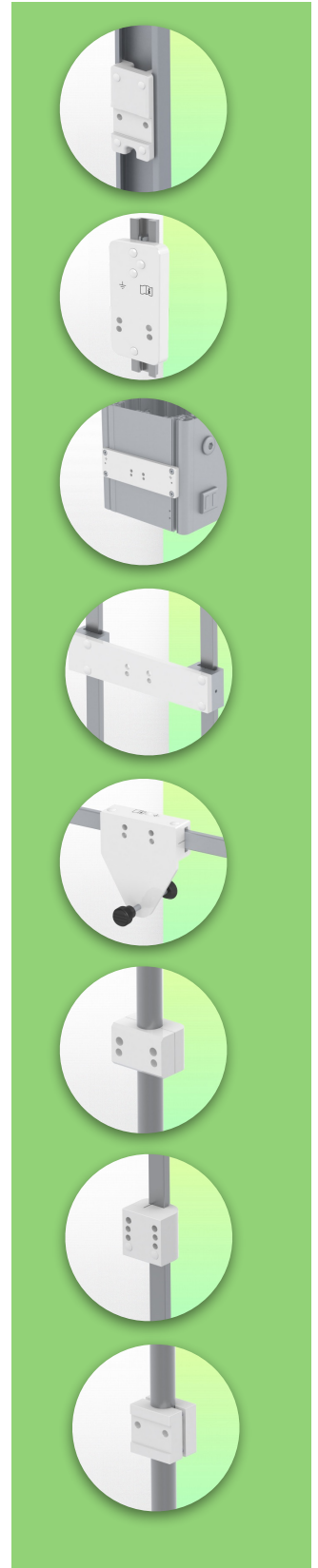

Height-adjustable medical arm, length 450 mm, for monitoring Philips Intellivue MP2/X2/X3 Séries, table column mounting. Supported weight balancing range from 0 to 3,5 Kg. mounting without power cable hook

Full cable integration and infection prevention thanks to easy-to-clean surfaces make this arm ideal for emergency care areas. Height adjustment for ergonomic, customised positioning of the monitor. This 450 mm Horizontal Medical Arm with gas-lift height adjustment enables the monitor to be fixed, oriented and adjusted perfectly. It is coated with an anti-microbial agent for hygiene and cleaning down to the smallest detail. Its modern design has been specially developed for healthcare environments.

Technical specifications:

- * Integral cable entry * Equipotential bonding * Optional Table columns are available in various heights (300 - 500 mm). These columns can be easily cut to size. All cables are also routed through the column. (See Option on the following pages) * This 450 mm gas-pressurised Horizontal Arm simply slides into the column rail, then adjusts to the required height and locks in place. It has a safety stop button for height adjustment, allowing the arm to remain in the chosen position.
- * The head of this arm is compatible with Philips Intellivue MP2/X2/X3 monitors.
- * Suitable for monitors weighing up to 0-3,5 Kg.
- * Monitor tilt: 30° down and 20° up
- * Monitor rotation: 135° right, 180° left. * Arm rotation: 90° right, 90° left
- * Height adjustment: 438 mm * Total length: 578 mm
- * All our medical arms comply with CE, ROHS, Medical Grade, Regulations MDD 93/42 ECC. * Colour: RAL 5013 cobalt blue and RAL 9016 traffic white
- * Warranty: 5 years

Technical specifications

Part Number: WM 260.140X

Height-adjustable medical arm, length 450 mm, for monitoring Philips Intellivue MP2/X2/X3 Séries, table column mounting. Supported weight balancing range from 0 to 3,5 Kg. mounting without power cable hook



Cette colonne possède deux rails de fixation pour les différents éléments qui y seront fixés. (1 rail à l'avant de la colonne, 1 rail à l'arrière)

This column has two fixing rails for the different elements that will be fixed to it (1 rail at the front of the column, 1 rail at the back)

Deze zuil heeft twee bevestigingsrails voor de verschillende elementen die eraan bevestigd zullen worden (1 rail aan de voorkant van de zuil, 1 rail aan de achterkant)

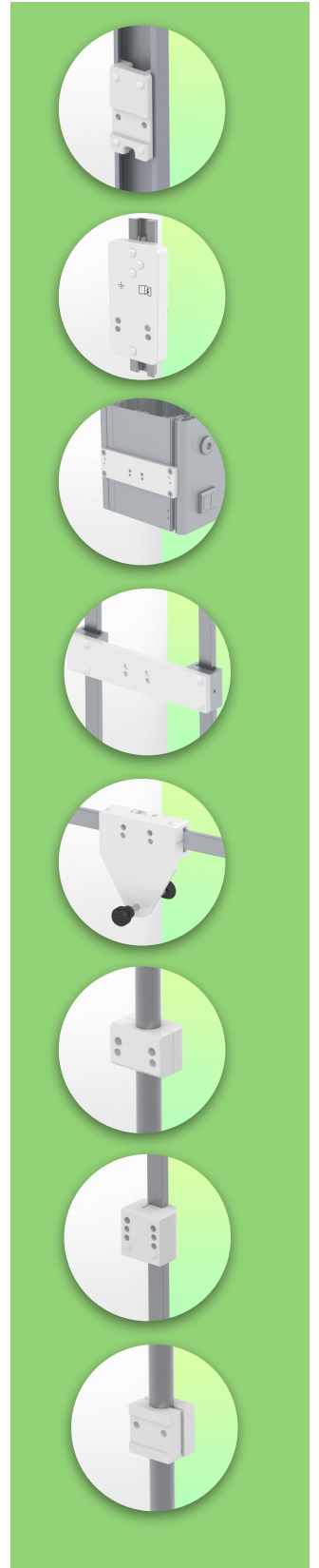
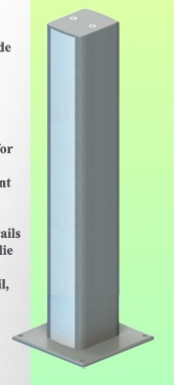

SIDE VIEW - VUE DE CÔTE - ZIJAAZICHT

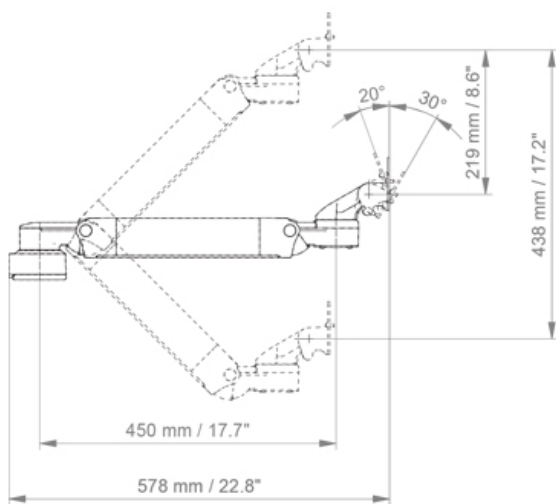

TOP VIEW
VUE DE DESSUS - BOVEN BEKIJKEN

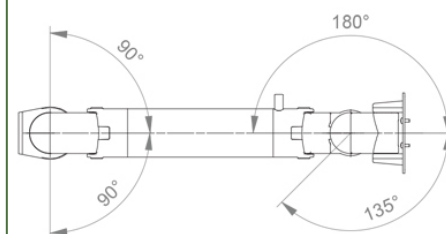

Monitor adaptation: Philips Intellivue MP2/X2/X3 Series

Height adjustment: Slow-release spring, parallel adapter for constant viewing angle

Colour: Decorative parts: RAL 5013 cobalt blue

Aluminium parts: RAL 9016 traffic white

Max. load capacity: 22 kg

Monitor adaptation max. load: 18 Kg

Balance scale on this medical arm: 0 - 3,5 Kg

Product weight: 3.5 Kg

Safety: Has a safety stop button for height adjustment, which allows the medical arm to remain in the chosen position.

Compatibility: Monitoring Philips Intellivue MP2/X2/X3 Series

Presentation

Part Number: WM 260.140X

Height-adjustable medical arm, length 450 mm, for monitoring Philips Intellivue MP2/X2/X3 Séries, table column mounting. Supported weight balancing range from 0 to 3,5 Kg. mounting without power cable hook

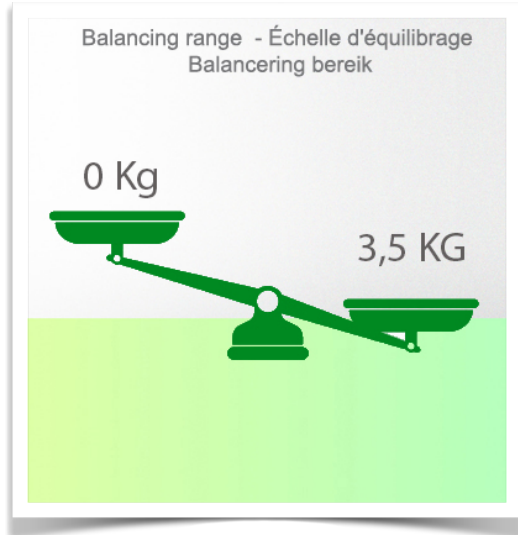
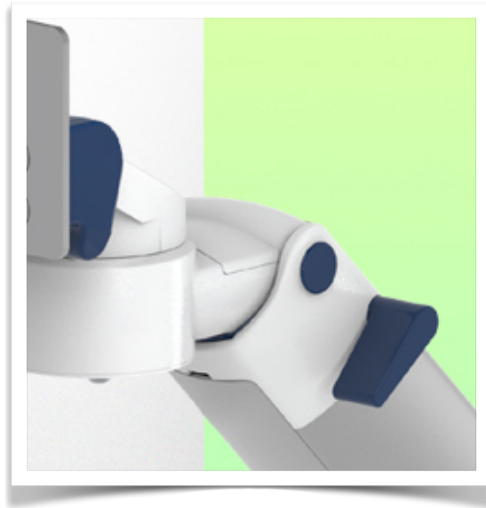
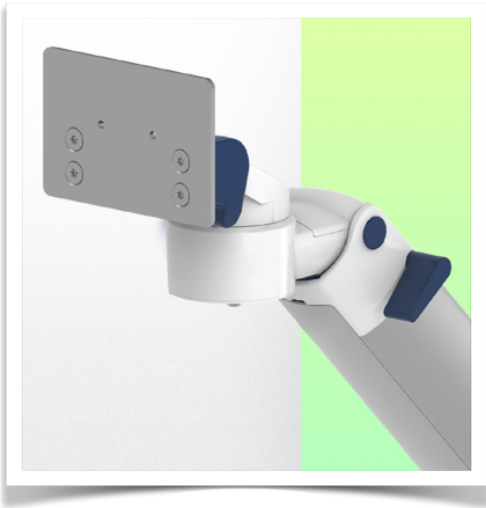

Installation information - Column Slide Rail

Part Number: WM 260.140X

Height-adjustable medical arm, length 450 mm, for monitoring Philips Intellivue MP2/X2/X3 Séries, table column mounting. Supported weight balancing range from 0 to 3,5 Kg. mounting without power cable hook

Table column:

To install this medical arm, you need to use one of our medical columns. These are available in standard heights of 500 and 300 mm. Custom heights are available on request. Slide covers and end caps are supplied with every order.

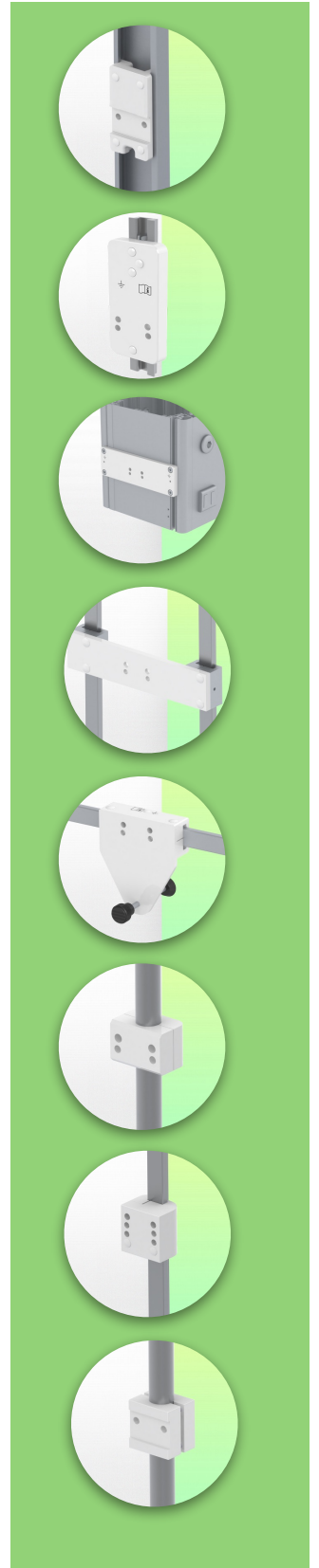
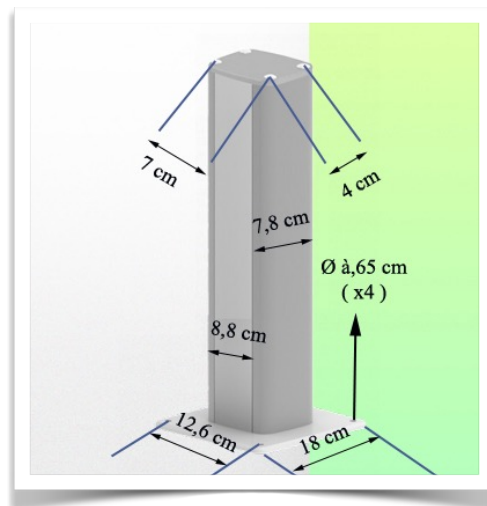
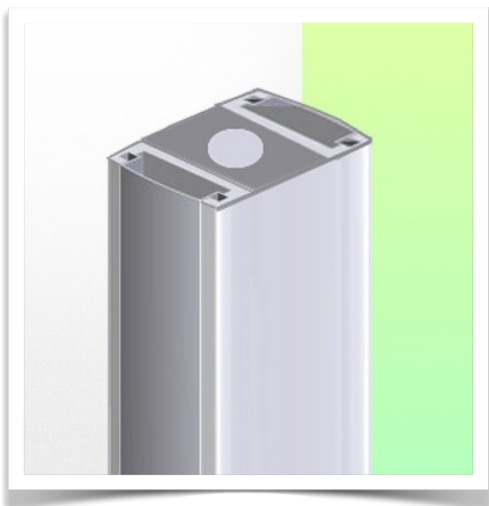
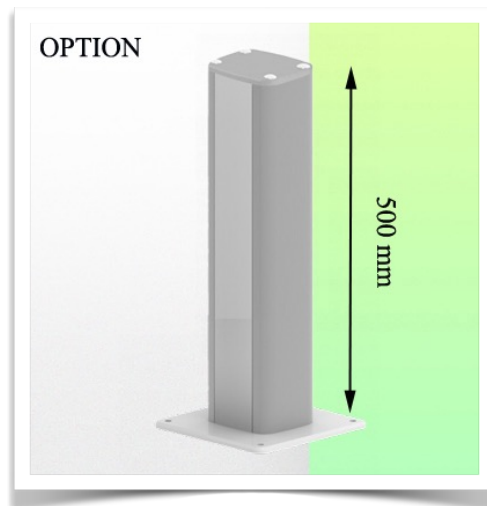
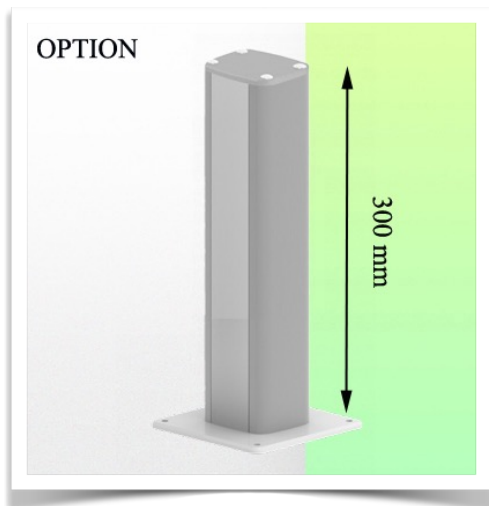

Presentation

Part Number: WM 260.140X

Height-adjustable medical arm, length 450 mm, for monitoring Philips Intellivue MP2/X2/X3 Séries, table column mounting. Supported weight balancing range from 0 to 3,5 Kg. mounting without power cable hook

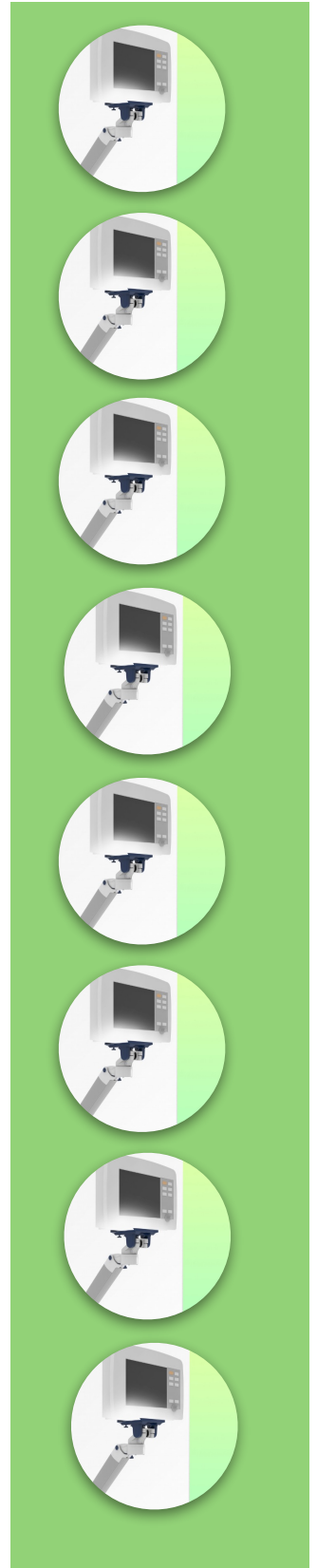
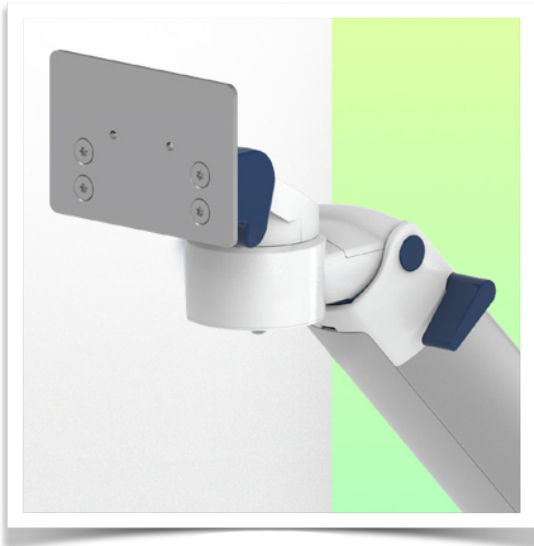

Adaptation monitoring Philips Intellivue MP2 / X2 / X3 series

All our medical arms can be fitted with this adaptation, some illustrations of which can be found here.

