

Presentation

Part Number: WM 260.155

Height-adjustable medical arm, length 450 mm, for monitoring Philips Intellivue Séries, Mounting on fixed pole diameter 25, 35 and 38 mm. Supported weight balancing range from 2 to 5 Kg.

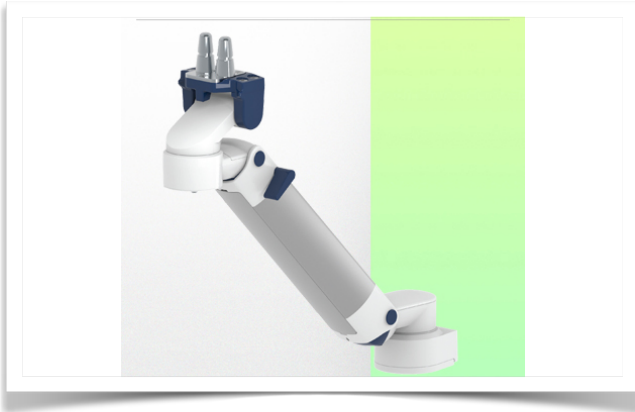

Height-adjustable medical arm, length 450 mm, for monitoring Philips Intellivue Séries, Mounting on fixed pole diameter 25, 35 and 38 mm. Supported weight balancing range from 2 to 5 Kg.

Full cable integration and infection prevention thanks to easy-to-clean surfaces make this arm ideal for emergency care areas. Height adjustment for ergonomic, customised positioning of the monitor. This 450 mm Horizontal Medical Arm with gas-lift height adjustment enables the monitor to be fixed, oriented and adjusted perfectly. It is coated with an anti-microbial agent for hygiene and cleaning down to the smallest detail. Its modern design has been specially developed for healthcare environments.

Technical specifications:

- * Integral cable entry * Equipotential bonding * This 450 mm Horizontal Arm with gas spring simply adjusts to the desired height and is fixed. It has a safety stop button for height adjustment, allowing the arm to remain in the chosen position.
- * The head of this arm is compatible with Philips Intellivue Series monitors.
- * Suitable for monitors weighing up to 2-5 Kg. * Monitor tilt: 21° down and 20° up
- * Monitor rotation: 115° right, 115° left. * Arm rotation: 105° right, 105° left
- * Height adjustment: 438 mm * Total length: 531 mm * All our medical arms comply with CE, ROHS, Medical Grade, Regulations MDD 93/42 ECC. * Colour: RAL 5013 cobalt blue and RAL 9016 traffic white * Warranty: 5 years

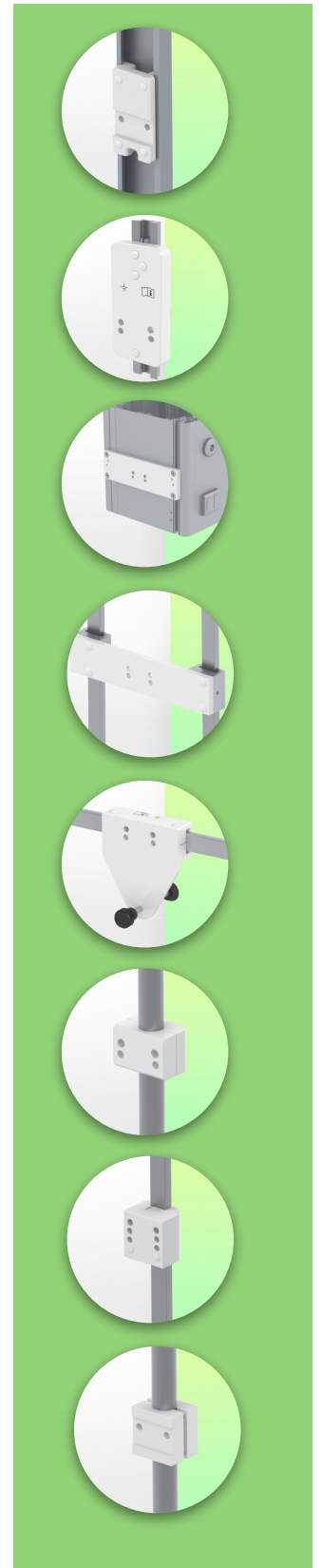

Technical specifications

Part Number: WM 260.155

Height-adjustable medical arm, length 450 mm, for monitoring Philips Intellivue Séries, Mounting on fixed pole diameter 25, 35 and 38 mm. Supported weight balancing range from 2 to 5 Kg.

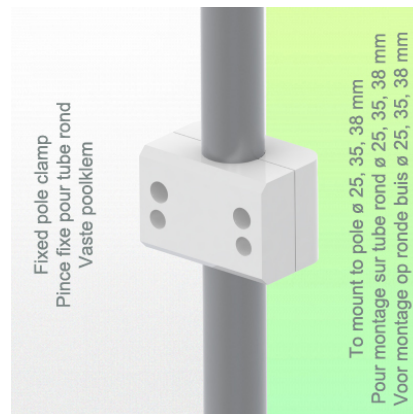
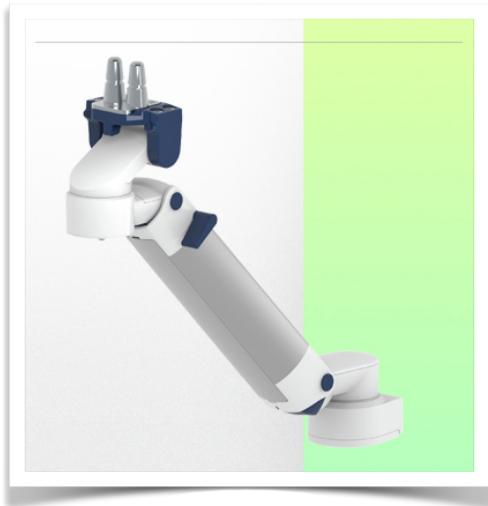

SIDE VIEW - VUE DE CÔTE - ZIJAAZICHT

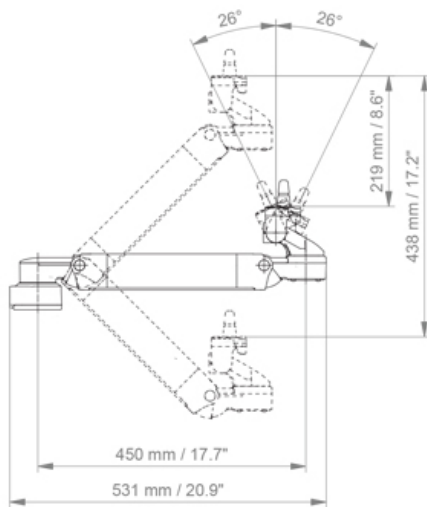

TOP VIEW
VUE DE DESSUS - BOVEN BEKIJKEN

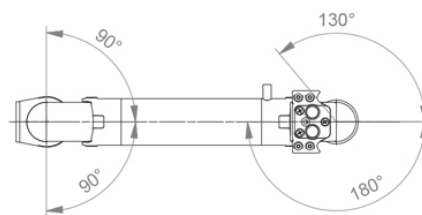

Monitor adaptation: Philips Intellivue Series

Height adjustment: Slow-release spring, parallel adapter for constant viewing angle

Colour: Decorative parts: RAL 5013 cobalt blue

Aluminium parts: RAL 9016 traffic white

Max. load capacity: 22 kg

Monitor adaptation max. load: 18 Kg

Balance scale on this medical arm: 2 - 5 Kg

Product weight: 3.8 Kg

Safety: Has a safety stop button for height adjustment, which allows the medical arm to remain in the chosen position.

Compatibility: Monitoring Philips Intellivue Series

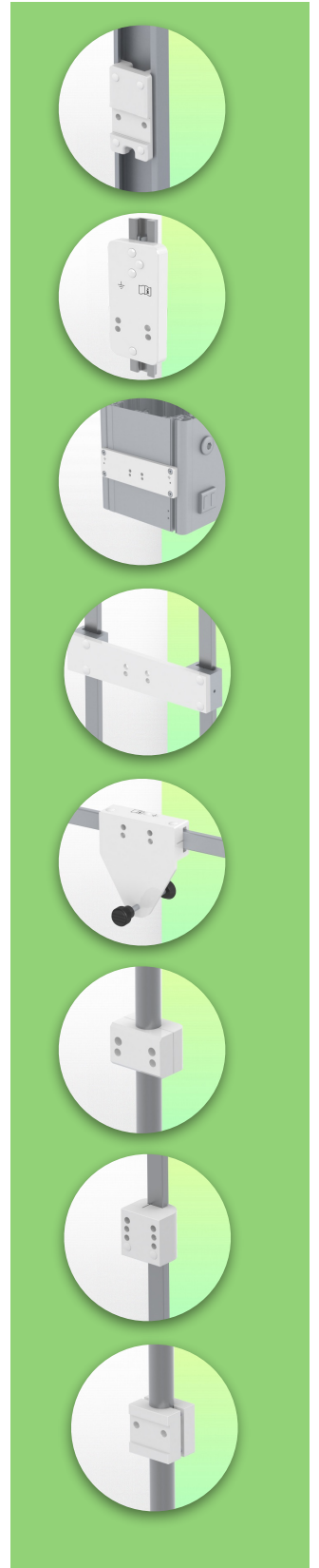

Presentation

Part Number: WM 260.155

Height-adjustable medical arm, length 450 mm, for monitoring Philips Intellivue Séries, Mounting on fixed pole diameter 25, 35 and 38 mm. Supported weight balancing range from 2 to 5 Kg.

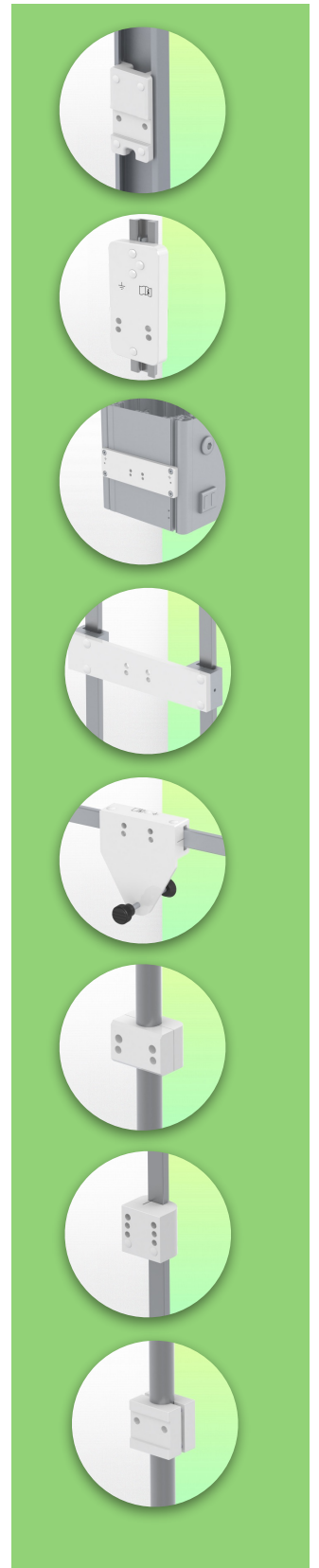
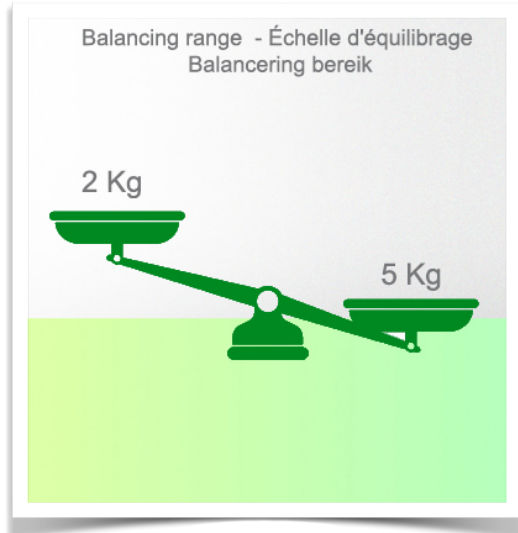

Installation information - Fixed pole clamp

Part Number: WM 260.155

Height-adjustable medical arm, length 450 mm, for monitoring Philips Intellivue Séries, Mounting on fixed pole diameter 25, 35 and 38 mm. Supported weight balancing range from 2 to 5 Kg.

Fixed pole clamp:

To mount to pole ø 25, 35, 38 mm

* Please specify the diameter of the Pole when ordering.

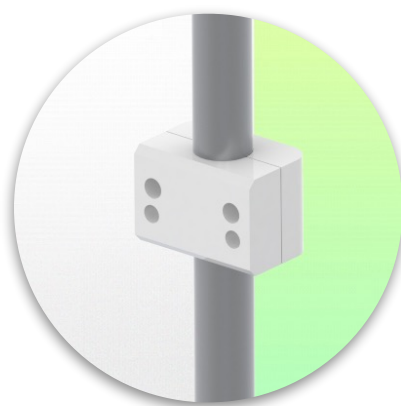
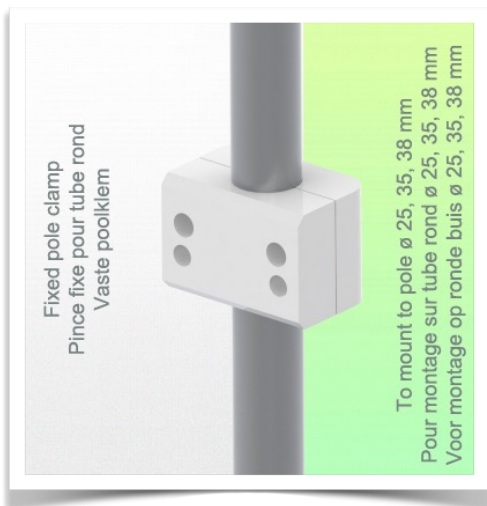

Presentation

Part Number: WM 260.155

Height-adjustable medical arm, length 450 mm, for monitoring Philips Intellivue Séries, Mounting on fixed pole diameter 25, 35 and 38 mm. Supported weight balancing range from 2 to 5 Kg.

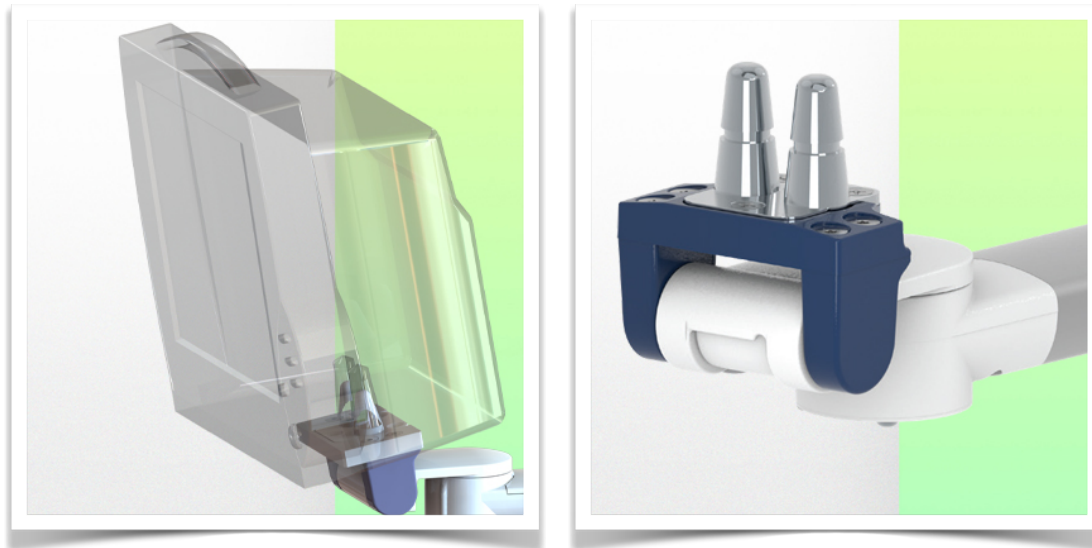

Adaptation monitoring Philips Intellivue series

All our medical arms can be fitted with this adaptation, some illustrations of which can be found here.

