

**Presentation**

**Part Number: WM 260.165**

**Height-adjustable medical arm, length 450 mm, for monitoring Philips Intellivue Séries, Mounting on Mindray Medical Power Supply Device. Supported weight balancing range from 2 to 5 Kg.**

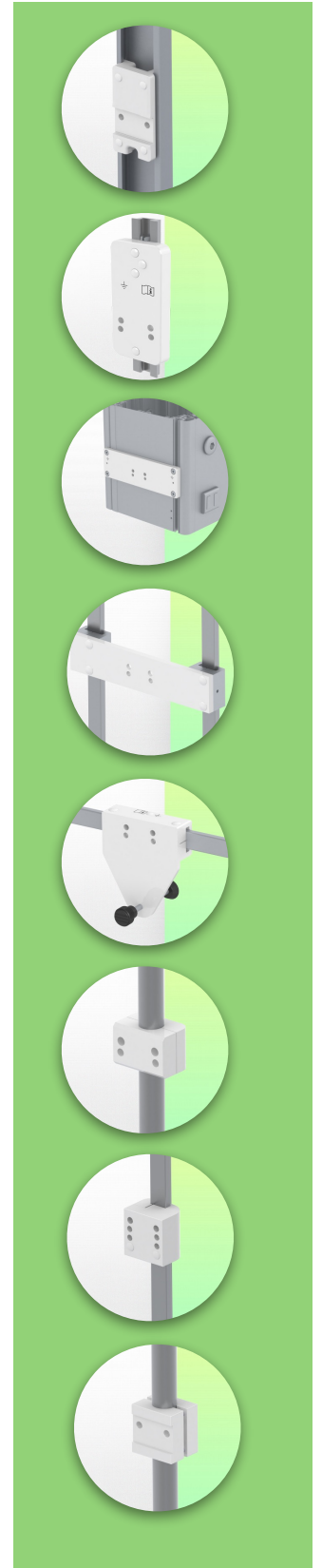
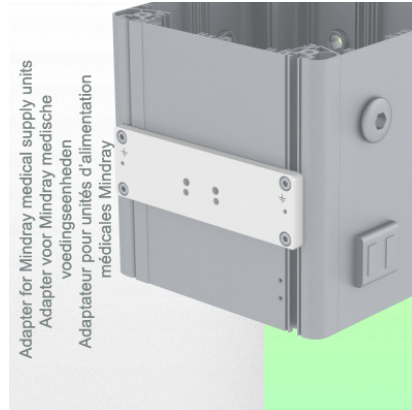
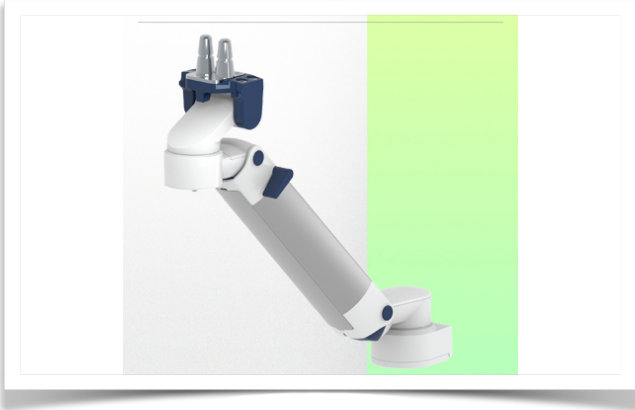

**Height-adjustable medical arm, length 450 mm, for monitoring Philips Intellivue Séries, Mounting on Mindray Medical Power Supply Device. Supported weight balancing range from 2 to 5 Kg.**

Full cable integration and infection prevention thanks to easy-to-clean surfaces make this arm ideal for emergency care areas. Height adjustment for ergonomic, customised positioning of the monitor. This 450 mm Horizontal Medical Arm with gas-lift height adjustment enables the monitor to be fixed, oriented and adjusted perfectly. It is coated with an anti-microbial agent for hygiene and cleaning down to the smallest detail. Its modern design has been specially developed for healthcare environments.

**Technical specifications:**

- \* Integral cable entry \* Equipotential bonding \* This 450 mm Horizontal Arm with gas spring simply adjusts to the desired height and is fixed. It has a safety stop button for height adjustment, allowing the arm to remain in the chosen position.
- \* The head of this arm is compatible with Philips Intellivue Series monitors.
- \* Suitable for monitors weighing up to 2-5 Kg. \* Monitor tilt: 21° down and 20° up
- \* Monitor rotation: 115° right, 115° left. \* Arm rotation: 105° right, 105° left
- \* Height adjustment: 438 mm \* Total length: 531 mm \* All our medical arms comply with CE, ROHS, Medical Grade, Regulations MDD 93/42 ECC.
- \* Colour: RAL 5013 cobalt blue and RAL 9016 traffic white \* Warranty: 5 years

## Technical specifications

Part Number: WM 260.165

Height-adjustable medical arm, length 450 mm, for monitoring Philips Intellivue Séries, Mounting on Mindray Medical Power Supply Device. Supported weight balancing range from 2 to 5 Kg.

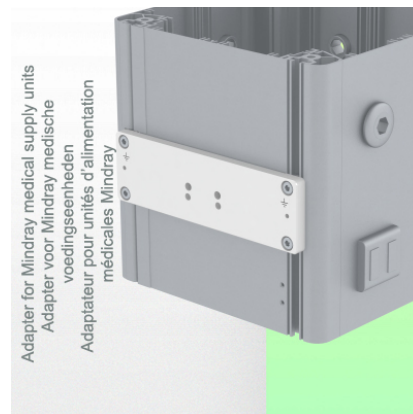

SIDE VIEW - VUE DE CÔTE - ZIJAAZICHT



TOP VIEW  
VUE DE DESSUS - BOVEN BEKIJKEN

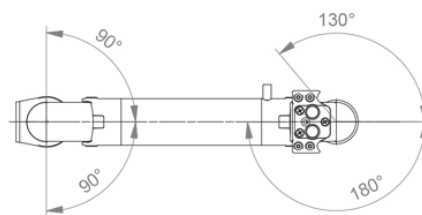

**Monitor adaptation:** Philips Intellivue Series

**Height adjustment:** Slow-release spring, parallel adapter for constant viewing angle

**Colour:** Decorative parts: RAL 5013 cobalt blue

**Aluminium parts:** RAL 9016 traffic white

**Max. load capacity:** 22 kg

**Monitor adaptation max. load:** 18 Kg

**Balance scale on this medical arm:** 2 - 5 Kg

**Product weight:** 3.8 Kg

**Safety:** Has a safety stop button for height adjustment, which allows the medical arm to remain in the chosen position.

**Compatibility:** Monitoring Philips Intellivue Series

**Presentation**

**Part Number: WM 260.165**

**Height-adjustable medical arm, length 450 mm, for monitoring Philips Intellivue Séries, Mounting on Mindray Medical Power Supply Device. Supported weight balancing range from 2 to 5 Kg.**

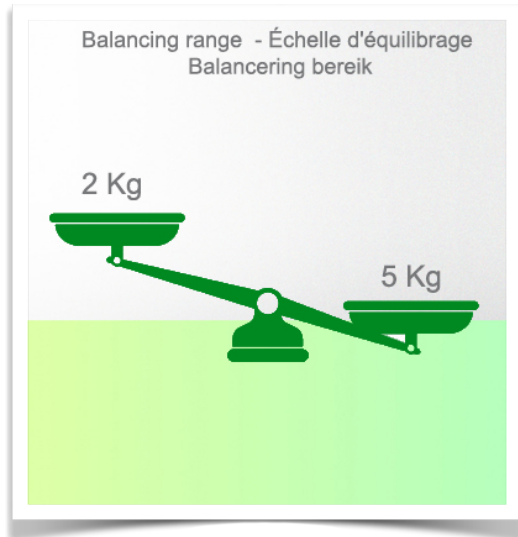

**Installation information - Adapter Mindray**

**Part Number: WM 260.165**

**Height-adjustable medical arm, length 450 mm, for monitoring Philips Intellivue Séries, Mounting on Mindray Medical Power Supply Device. Supported weight balancing range from 2 to 5 Kg.**

**Adapter Mindray:**

Mounting on Mindray Medical Supply Device

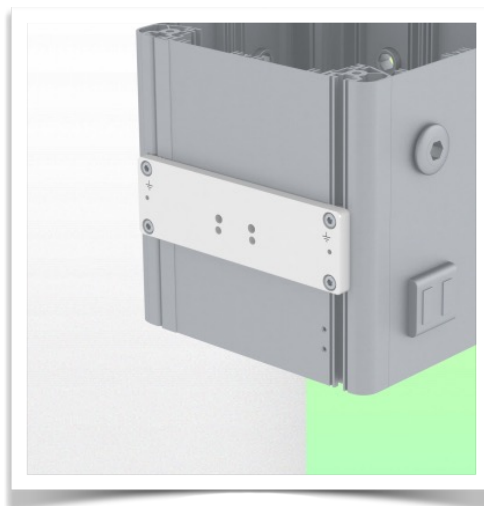
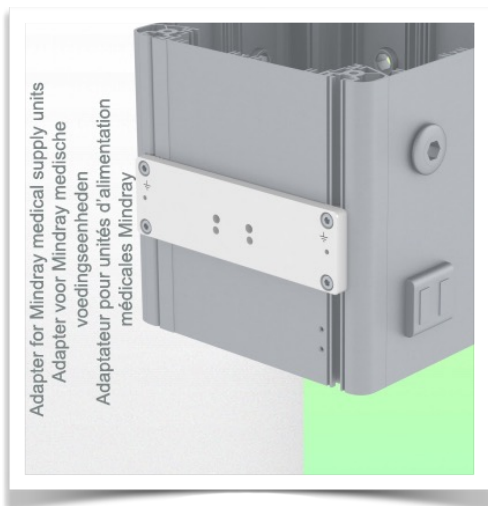



**Presentation**

**Part Number: WM 260.165**

**Height-adjustable medical arm, length 450 mm, for monitoring Philips Intellivue Séries, Mounting on Mindray Medical Power Supply Device. Supported weight balancing range from 2 to 5 Kg.**

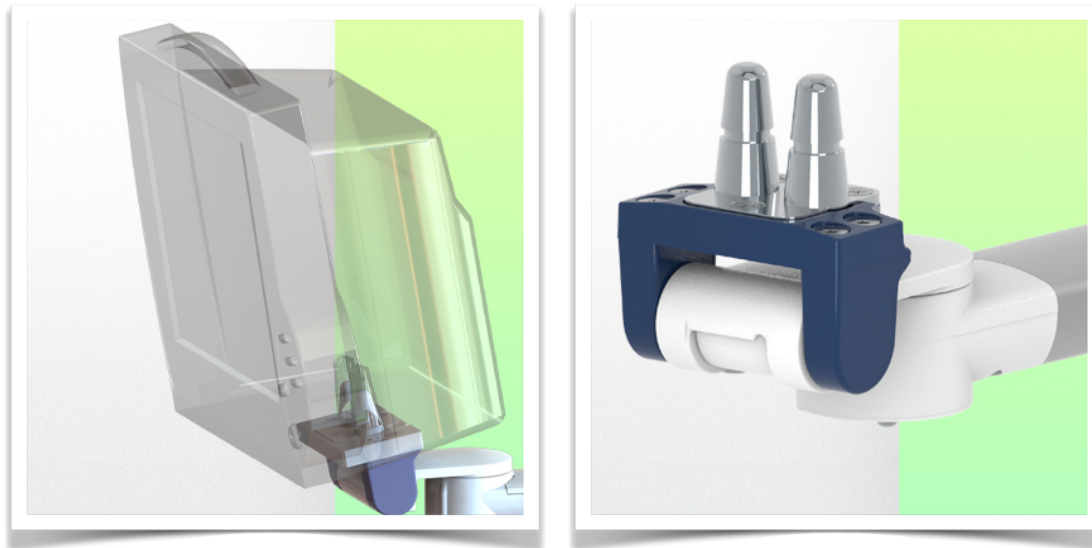

**Adaptation monitoring Philips Intellivue series**

All our medical arms can be fitted with this adaptation, some illustrations of which can be found here.

