

Presentation

Part Number: WM 260.169

Height-adjustable medical arm, length 450 mm, for monitoring Philips Intellivue Séries, Mounting on Mindray Medical Power Supply Device. Supported weight balancing range from 16 to 22 Kg.

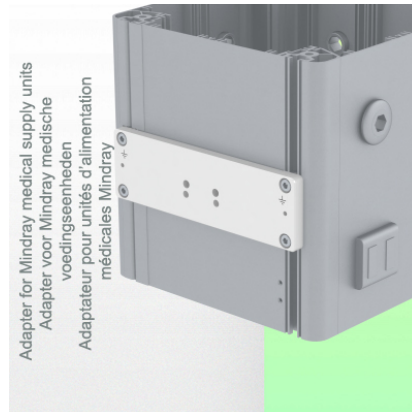
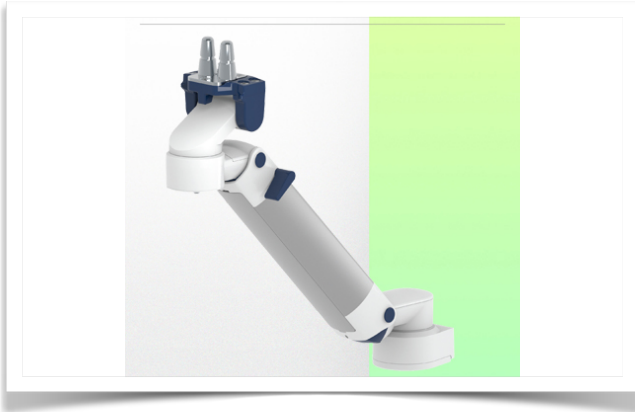

Height-adjustable medical arm, length 450 mm, for monitoring Philips Intellivue Séries, Mounting on Mindray Medical Power Supply Device. Supported weight balancing range from 16 to 22 Kg.

Full cable integration and infection prevention thanks to easy-to-clean surfaces make this arm ideal for emergency care areas. Height adjustment for ergonomic, customised positioning of the monitor. This 450 mm Horizontal Medical Arm with gas-lift height adjustment enables the monitor to be fixed, oriented and adjusted perfectly. It is coated with an anti-microbial agent for hygiene and cleaning down to the smallest detail. Its modern design has been specially developed for healthcare environments.

Technical specifications:

- * Integral cable entry * Equipotential bonding * This 450 mm Horizontal Arm with gas spring simply adjusts to the desired height and is fixed. It has a safety stop button for height adjustment, allowing the arm to remain in the chosen position.
- * The head of this arm is compatible with Philips Intellivue Series monitors.
- * Suitable for monitors weighing up to 16-22 Kg. * Monitor tilt: 21° down and 20° up * Monitor rotation: 115° right, 115° left. * Arm rotation: 105° right, 105° left
- * Height adjustment: 438 mm * Total length: 531 mm * All our medical arms comply with CE, ROHS, Medical Grade, Regulations MDD 93/42 ECC.
- * Colour: RAL 5013 cobalt blue and RAL 9016 traffic white * Warranty: 5 years

Technical specifications

Part Number: WM 260.169

Height-adjustable medical arm, length 450 mm, for monitoring Philips Intellivue Séries, Mounting on Mindray Medical Power Supply Device. Supported weight balancing range from 16 to 22 Kg.

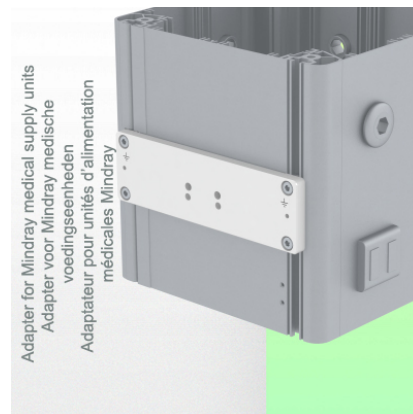

SIDE VIEW - VUE DE CÔTE - ZIJAAZICHT



TOP VIEW
VUE DE DESSUS - BOVEN BEKIJKEN

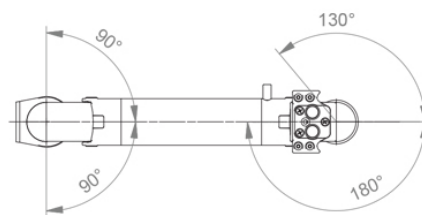

Monitor adaptation: Philips Intellivue Series

Height adjustment: Slow-release spring, parallel adapter for constant viewing angle

Colour: Decorative parts: RAL 5013 cobalt blue

Aluminium parts: RAL 9016 traffic white

Max. load capacity: 22 kg

Monitor adaptation max. load: 18 Kg

Balance scale on this medical arm: 16 - 22 Kg

Product weight: 3.8 Kg

Safety: Has a safety stop button for height adjustment, which allows the medical arm to remain in the chosen position.

Compatibility: Monitoring Philips Intellivue Series

Presentation

Part Number: WM 260.169

Height-adjustable medical arm, length 450 mm, for monitoring Philips Intellivue Séries, Mounting on Mindray Medical Power Supply Device. Supported weight balancing range from 16 to 22 Kg.

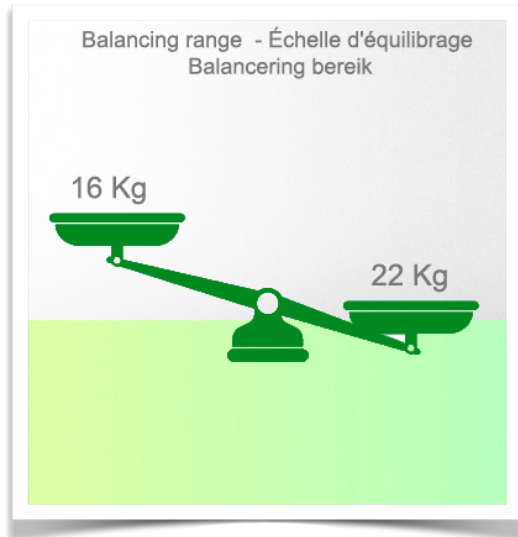

Installation information - Adapter Mindray

Part Number: WM 260.169

Height-adjustable medical arm, length 450 mm, for monitoring Philips Intellivue Séries, Mounting on Mindray Medical Power Supply Device. Supported weight balancing range from 16 to 22 Kg.

Adapter Mindray:

Mounting on Mindray Medical Supply Device

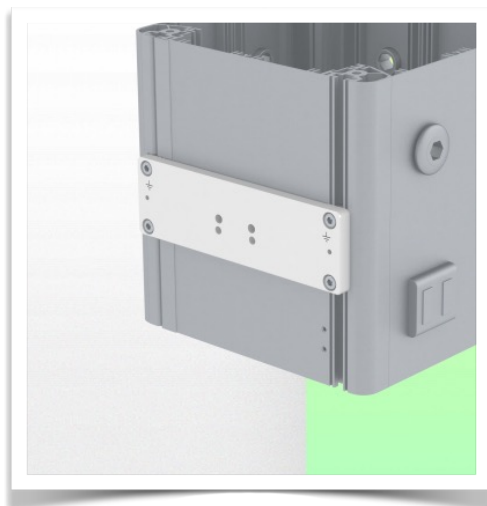
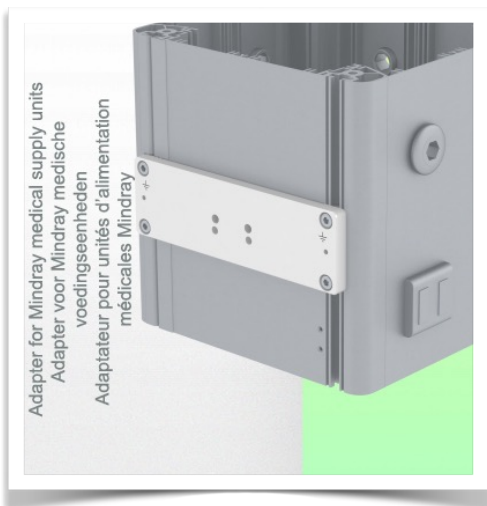

Presentation

Part Number: WM 260.169

Height-adjustable medical arm, length 450 mm, for monitoring Philips Intellivue Séries, Mounting on Mindray Medical Power Supply Device. Supported weight balancing range from 16 to 22 Kg.



Adaptation monitoring Philips Intellivue series

All our medical arms can be fitted with this adaptation, some illustrations of which can be found here.

