

Presentation

Part Number: WM 260.181

Extended Height Adjustable Arm, 761 mm, for monitoring Philips Intellivue Séries, floor or ceiling column mounting. Supported weight balancing range from 4 to 9 Kg.

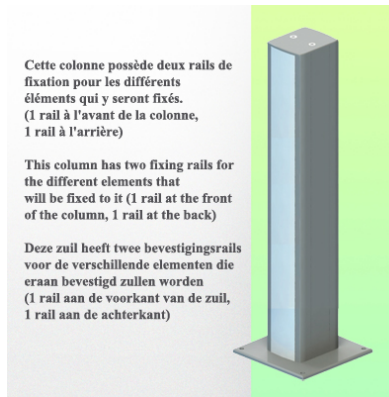
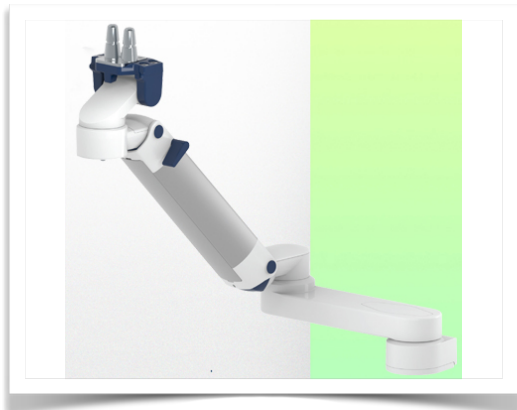

Extended Height Adjustable Arm, 761 mm, for monitoring Philips Intellivue Séries, floor or ceiling column mounting. Supported weight balancing range from 4 to 9 Kg.

Full cable integration and infection prevention thanks to easy-to-clean surfaces make this arm ideal for emergency care areas. Height adjustment for ergonomic, customised positioning of the monitor. This Horizontal Double Medical Arm with gas-lift height adjustment enables the monitor to be fixed, oriented and adjusted perfectly. It is coated with an anti-microbial agent for hygiene and cleaning down to the smallest detail. Its modern design has been specially developed for healthcare environments.

Technical specifications:

* Integrated cable passage * Equipotential bonding * Optional floor or ceiling columns are available in various heights (1500 - 2000 mm). These columns can be easily cut to size. All cables are also routed through the column. (See Option on the following pages) * This gas-operated Double Arm simply slides into the column rail, then adjusts to the required height and locks into place. It has a safety stop button for height adjustment, which allows the arm to remain in the chosen position. * The head of this arm is fitted for Philips Intellivue Tries * Compatible with monitors weighing no more than 4-9 Kg * Monitor tilt: 21° down and 20° up * Screen rotation: 130° right, 180° left. * Arm rotation: 90° right, 90° left * Height adjustment: 438 mm * Total length 761 mm * All our medical arms comply with CE, ROHS, Medical Grade, Regulations MDD 93/42 ECC. * Colour: RAL 5013 cobalt blue and RAL 9016 traffic white * Warranty: 5 years



Technical specifications

Part Number: WM 260.181

Extended Height Adjustable Arm, 761 mm, for monitoring Philips Intellivue Séries, floor or ceiling column mounting. Supported weight balancing range from 4 to 9 Kg.

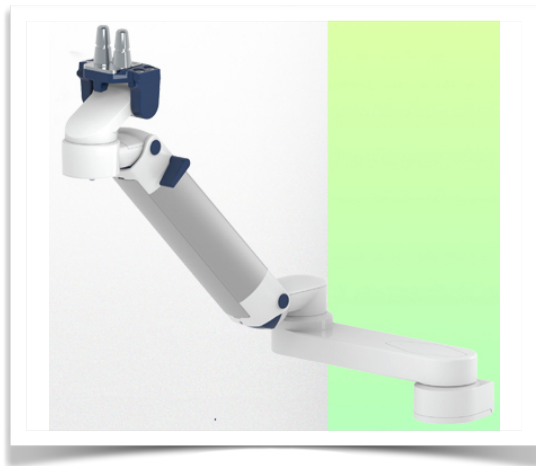

Cette colonne possède deux rails de fixation pour les différents éléments qui y seront fixés.
(1 rail à l'avant de la colonne, 1 rail à l'arrière)

This column has two fixing rails for the different elements that will be fixed to it (1 rail at the front of the column, 1 rail at the back)

Deze zuil heeft twee bevestigingsrails voor de verschillende elementen die eraan bevestigd zullen worden
(1 rail aan de voorkant van de zuil, 1 rail aan de achterkant)

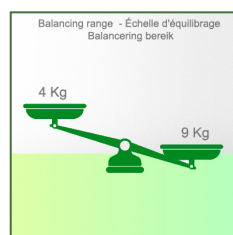
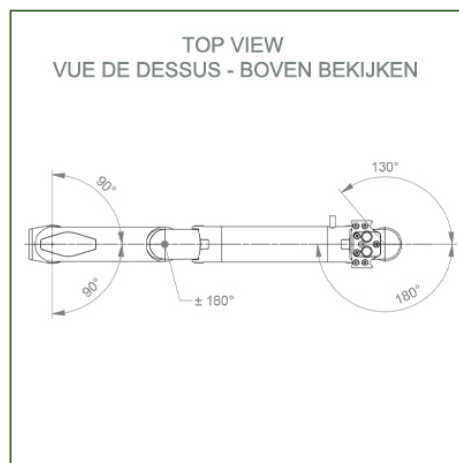
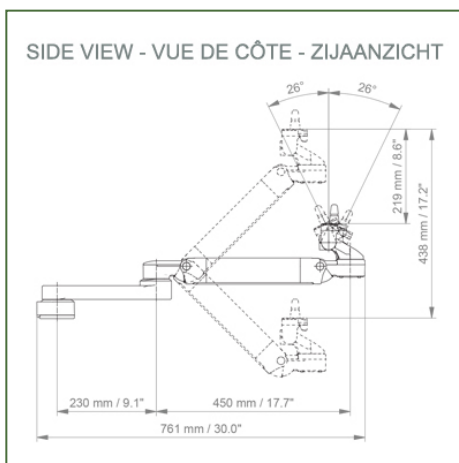

Monitor adaptation: Philips Intellivue Series
Colour: Decorative parts: RAL 5013 cobalt blue
Aluminium parts: RAL 9016 traffic white
Max. load capacity of support arm: 22 kg
Max. load monitor adaptation: 18 Kg
Balancing scale for this medical arm: 4 - 9 Kg
Product weight: 4,9 Kg

Height adjustment: parallel mechanism for a constant viewing angle

Safety: Has a safety stop button for height adjustment, allowing the medical arm to remain in the chosen position.

Installation information - Column Slide Rail

Part Number: WM 260.181

Extended Height Adjustable Arm, 761 mm, for monitoring Philips Intellivue Séries, floor or ceiling column mounting. Supported weight balancing range from 4 to 9 Kg.

Floor or ceiling column:

To install this medical arm, you need to use one of our medical columns. These are available in standard heights of 1500 and 2000 mm. Custom heights are available on request. Slide covers and end caps are supplied with every order.

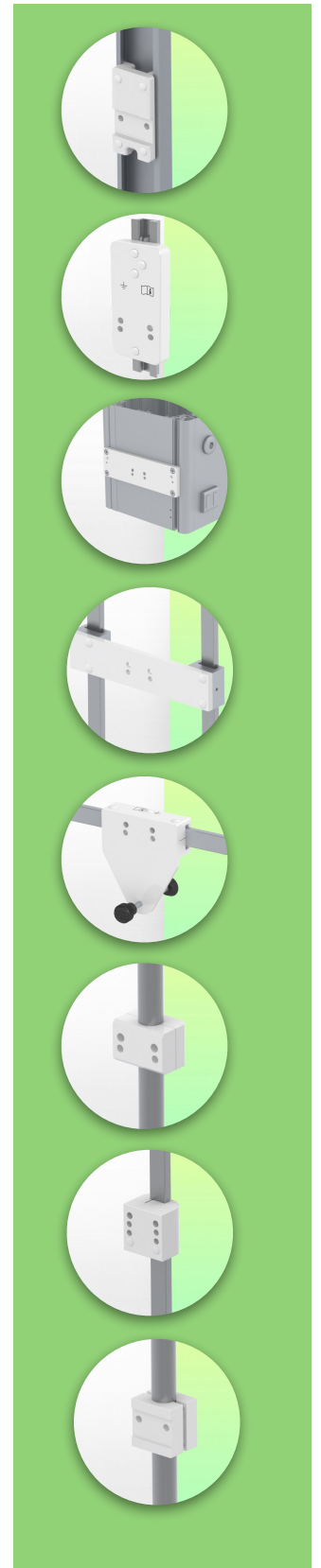
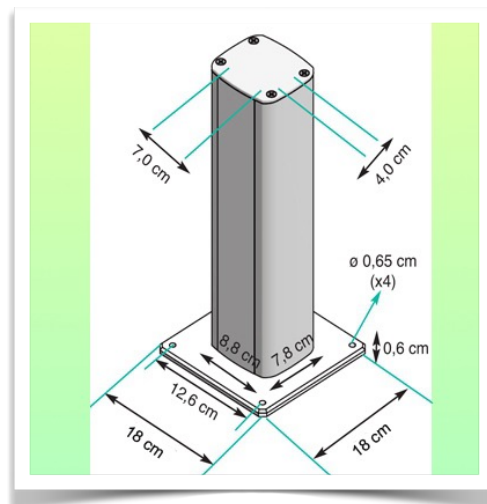
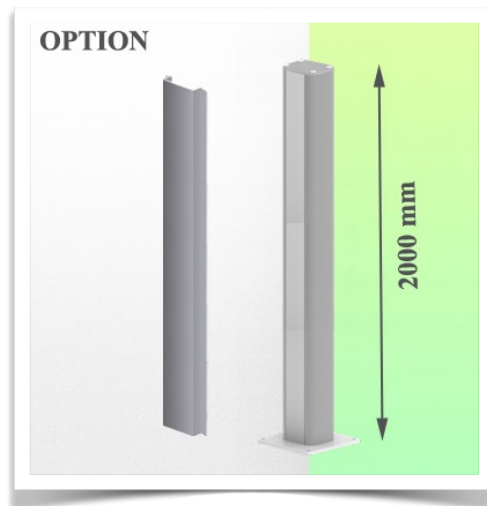
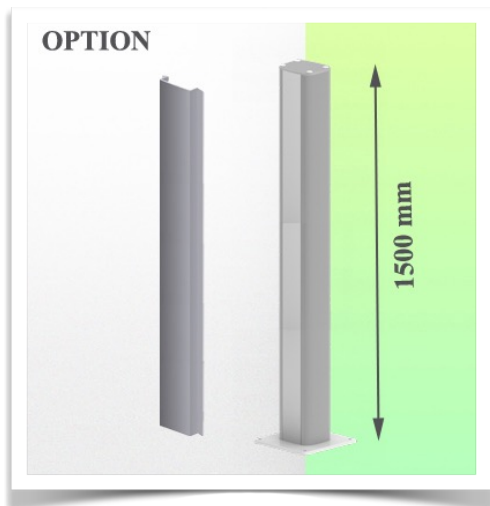

Presentation

Part Number: WM 260.181

Extended Height Adjustable Arm, 761 mm, for monitoring Philips Intellivue Série, floor or ceiling column mounting. Supported weight balancing range from 4 to 9 Kg.

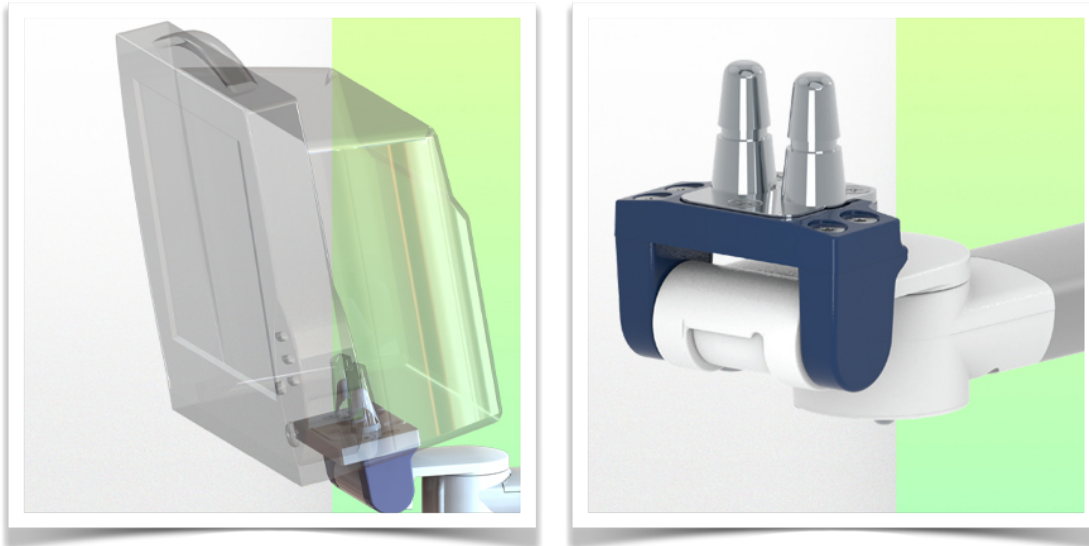

Adaptation monitoring Philips Intellivue series

All our medical arms can be fitted with this adaptation, some illustrations of which can be found here.

