

Presentation

Part Number: WM 260.198

Extended Height Adjustable Arm 761 mm, for monitoring Philips Intellivue Séries, Vertical Din rail mounting. Supported weight balancing range from 13 to 16 Kg.

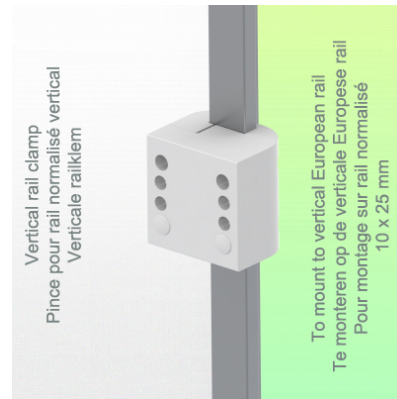

Extended Height Adjustable Arm 761 mm, for monitoring Philips Intellivue Séries, Vertical Din rail mounting. Supported weight balancing range from 13 to 16 Kg.

Full cable integration and infection prevention thanks to easy-to-clean surfaces make this arm ideal for emergency care areas. Height adjustment for ergonomic, customised positioning of the monitor. This Horizontal Double Medical Arm with gas-lift height adjustment enables the monitor to be fixed, oriented and adjusted perfectly. It is coated with an anti-microbial agent for hygiene and cleaning down to the smallest detail. Its modern design has been specially developed for healthcare environments.

Technical specifications:

* Integrated cable passage * Equipotential bonding * Fixing on the chosen adapter solution* This gas-operated Double Arm simply slides into the column rail, then adjusts to the required height and locks into place. It has a safety stop button for height adjustment, which allows the arm to remain in the chosen position. * The head of this arm is fitted for Philips Intellivue Series * Compatible with monitors weighing no more than 13-16 Kg * Monitor tilt: 21° down and 20° up * Screen rotation: 130° right, 180° left. * Arm rotation: 90° right, 90° left * Height adjustment: 438 mm * Total length 761 mm * All our medical arms comply with CE, ROHS, Medical Grade, Regulations MDD 93/42 ECC. * Colour: RAL 5013 cobalt blue and RAL 9016 traffic white * Warranty: 5 years

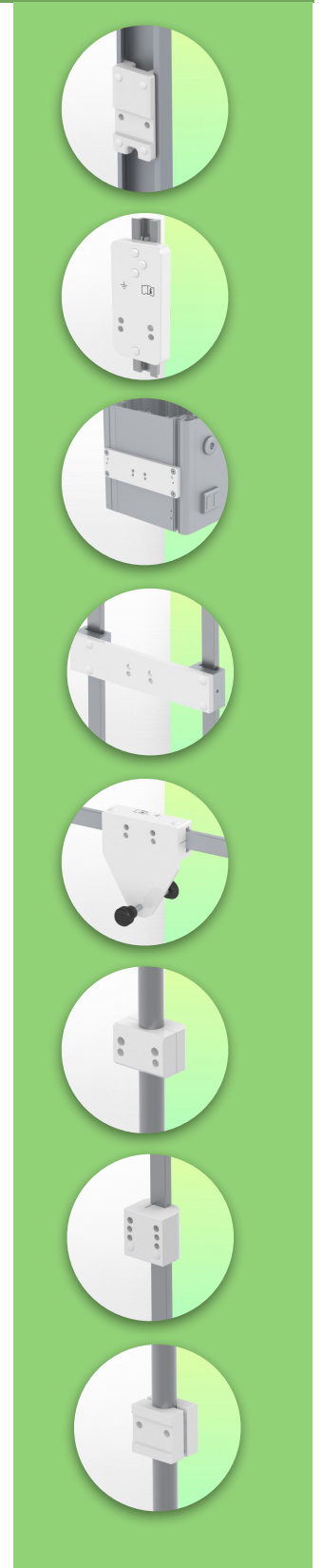

Technical specifications

Part Number: WM 260.198

Extended Height Adjustable Arm 761 mm, for monitoring Philips Intellivue Séries, Vertical Din rail mounting. Supported weight balancing range from 13 to 16 Kg.

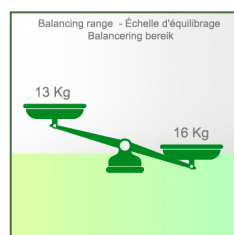
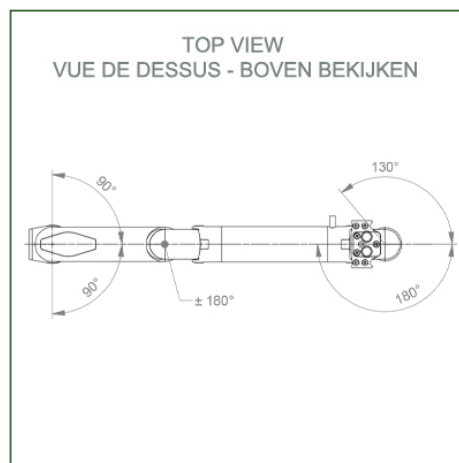
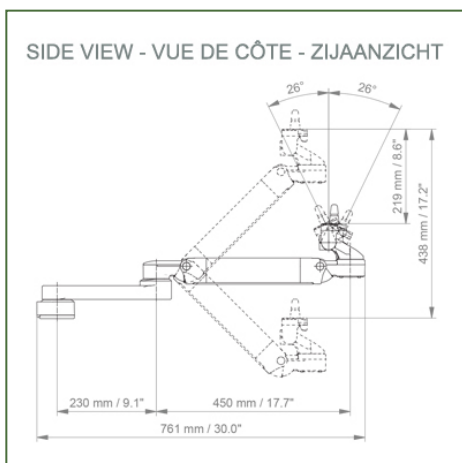
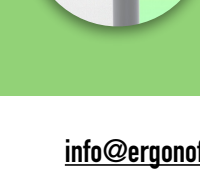
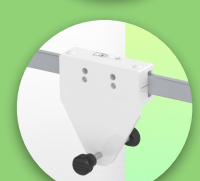
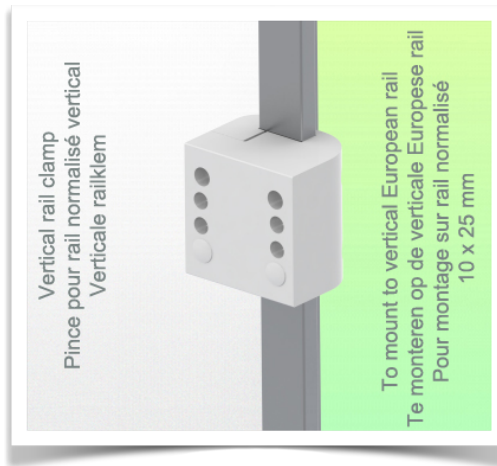
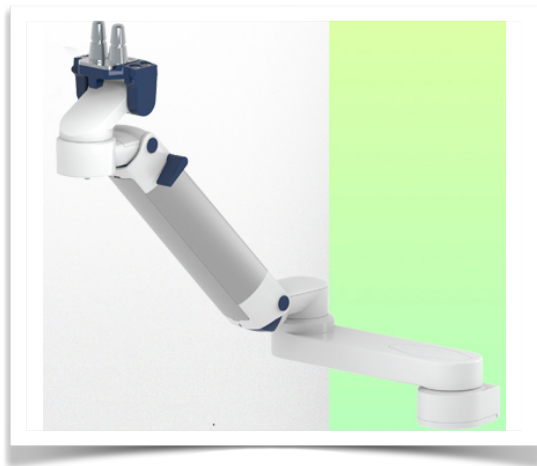

Monitor adaptation: Philips Intellivue Series
Colour: Decorative parts: RAL 5013 cobalt blue
 Aluminium parts: RAL 9016 traffic white
Max. load capacity of support arm: 22 kg
Max. load monitor adaptation: 18 Kg
Balancing scale for this medical arm: 13 - 16 Kg
Product weight: 4,9 Kg

Height adjustment: parallel mechanism for a constant viewing angle

Safety: Has a safety stop button for height adjustment, allowing the medical arm to remain in the chosen position.

Installation information - Adapter Din Rail Vertical

Part Number: WM 260.198

Extended Height Adjustable Arm 761 mm, for monitoring Philips Intellivue Séries, Vertical Din rail mounting. Supported weight balancing range from 13 to 16 Kg.

Din Rail Vertical:

Fixed standard rail clamp For mounting on vertical standard rail 10 x 25 mm

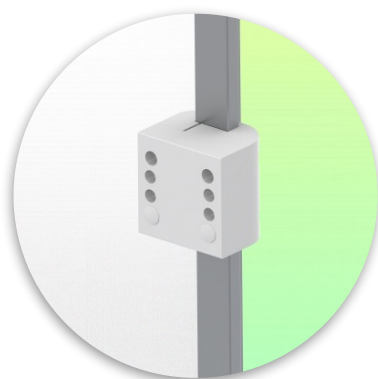
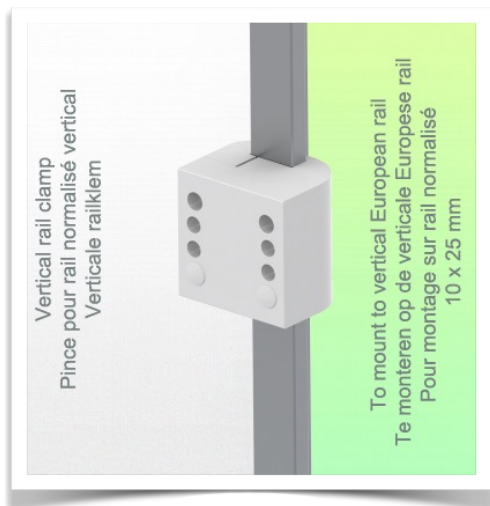

Presentation

Part Number: WM 260.198

Extended Height Adjustable Arm 761 mm, for monitoring Philips Intellivue Séries, Vertical Din rail mounting. Supported weight balancing range from 13 to 16 Kg.

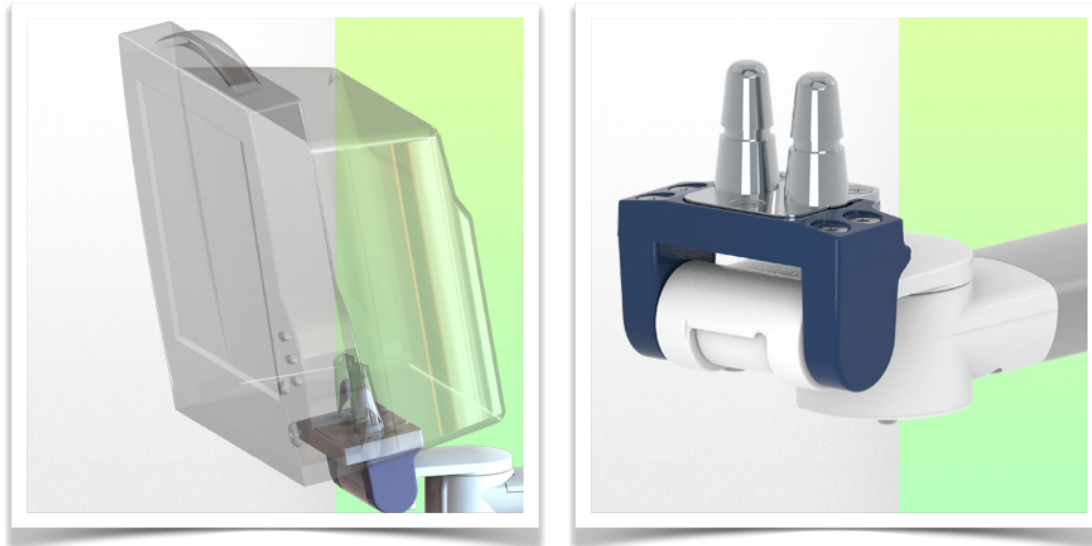

Adaptation monitoring Philips Intellivue series

All our medical arms can be fitted with this adaptation, some illustrations of which can be found here.

