

**Presentation**

**Part Number: WM 260.200X**

**Extended Height Adjustable Medical Arm 808 mm, for monitoring Philips Intellivue MP2/X2/X3 Séries, Mounting on fixed pole diameter 25, 35 and 38 mm. Supported weight balancing range from 0 to 3,5 Kg. mounting without power cable hook**

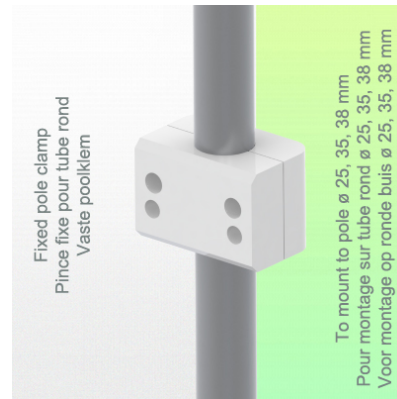
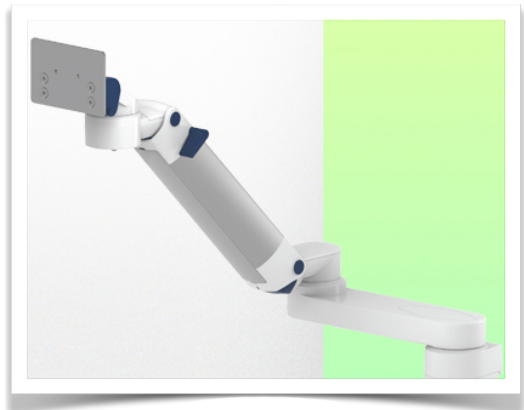

**Extended Height Adjustable Medical Arm 808 mm, for monitoring Philips Intellivue MP2/X2/X3 Séries, Mounting on fixed pole diameter 25, 35 and 38 mm. Supported weight balancing range from 0 to 3,5 Kg. mounting without power cable hook**

Full cable integration and infection prevention thanks to easy-to-clean surfaces make this arm ideal for emergency care areas. Height adjustment for ergonomic, customised positioning of the monitor. This Horizontal Double Medical Arm with gas-lift height adjustment enables the monitor to be fixed, oriented and adjusted perfectly. It is coated with an anti-microbial agent for hygiene and cleaning down to the smallest detail. Its modern design has been specially developed for healthcare environments.

**Technical specifications:**

- \* Integrated cable passage \* Equipotential bonding \* Fixing on the chosen adapter solution\* This gas-operated Double Arm simply slides into the column rail, then adjusts to the required height and locks into place. It has a safety stop button for height adjustment, which allows the arm to remain in the chosen position.
- \* The head of this arm is fitted for Philips Intellivue MP2/X2/X3 Series
- \* Compatible with monitors weighing no more than 0-3,5 Kg
- \* Monitor tilt: 30° down and 20° up \* Screen rotation: 135° right, 180° left.
- \* Arm rotation: 90° right, 90° left \* Height adjustment: 438 mm
- \* Total length 808 mm \* All our medical arms comply with CE, ROHS, Medical Grade, Regulations MDD 93/42 ECC. \* Colour: RAL 5013 cobalt blue and RAL 9016 traffic white \* Warranty: 5 years

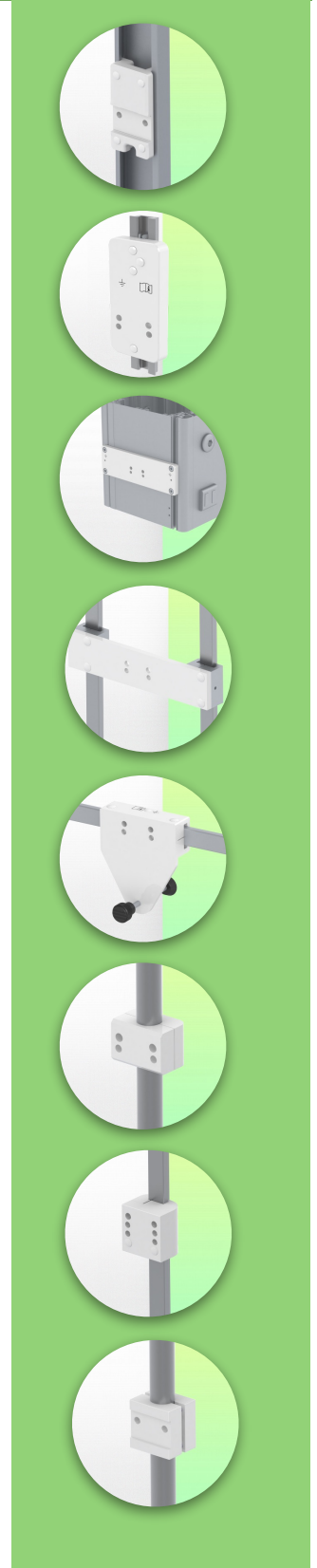

**Technical specifications**

**Part Number: WM 260.200X**

**Extended Height Adjustable Medical Arm 808 mm, for monitoring Philips Intellivue MP2/X2/X3 Séries, Mounting on fixed pole diameter 25, 35 and 38 mm. Supported weight balancing range from 0 to 3,5 Kg. mounting without power cable hook**

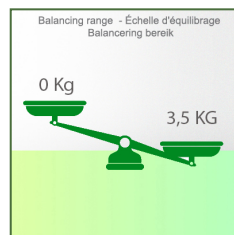
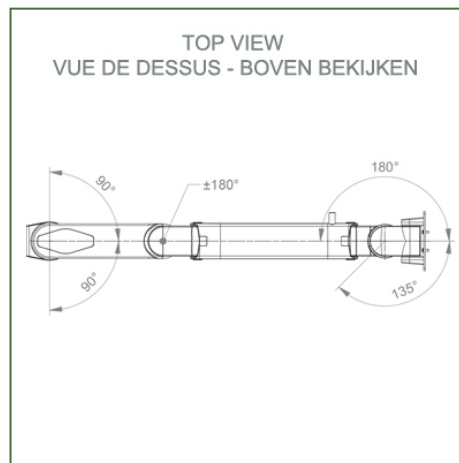
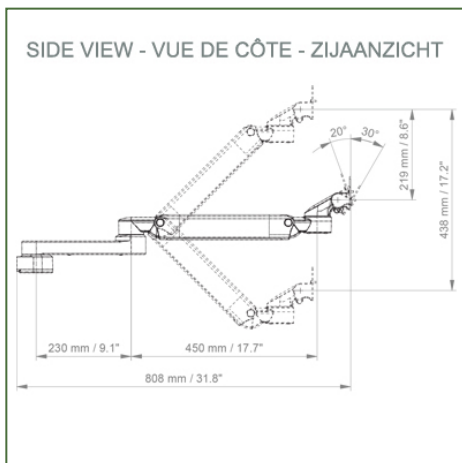
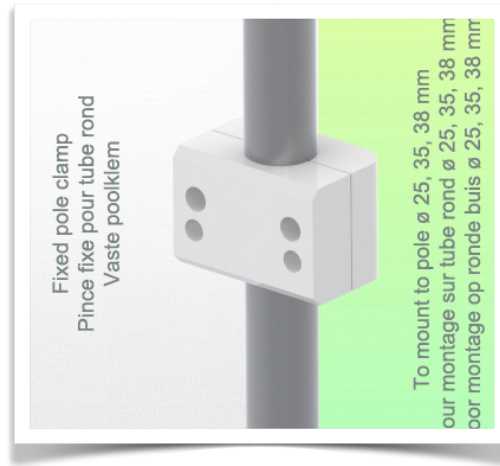
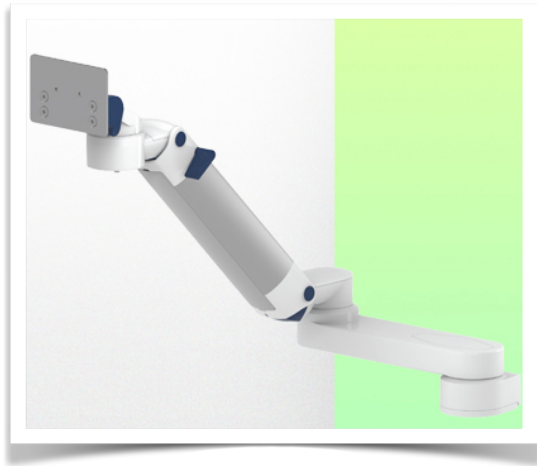

**Monitor adaptation:** Philips Intellivue MP2/X2/X3 Series

**Colour: Decorative parts:** RAL 5013 cobalt blue

**Aluminium parts:** RAL 9016 traffic white

**Max. load capacity of support arm:** 22 kg

**Max. load monitor adaptation:** 18 Kg

**Balancing scale for this medical arm:** 0 - 3,5 Kg

**Product weight:** 4,5 Kg

**Height adjustment:** parallel mechanism for a constant viewing angle

**Safety:** Has a safety stop button for height adjustment, allowing the medical arm to remain in the chosen position.

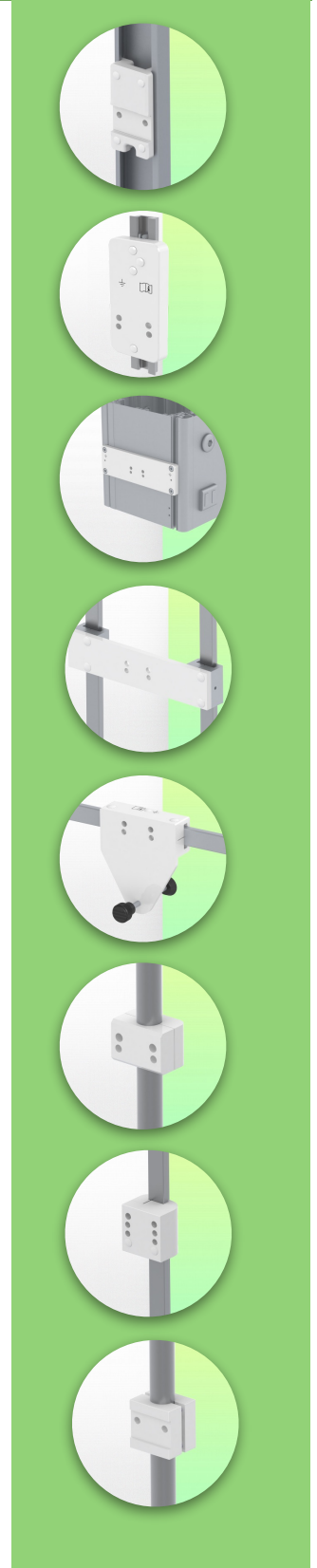

**Installation information - Adapter Fixed Pole Clamp**

**Part Number: WM**

**Extended Height Adjustable Medical Arm 808 mm, for monitoring Philips Intellivue MP2/X2/X3 Séries, Mounting on fixed pole diameter 25, 35 and 38 mm. Supported weight balancing range from 0 to 3,5 Kg. mounting without power cable hook**

**Fixed pole clamp:**

To mount to pole ø 25, 35, 38 mm

\* Please specify the diameter of the Pole when ordering.

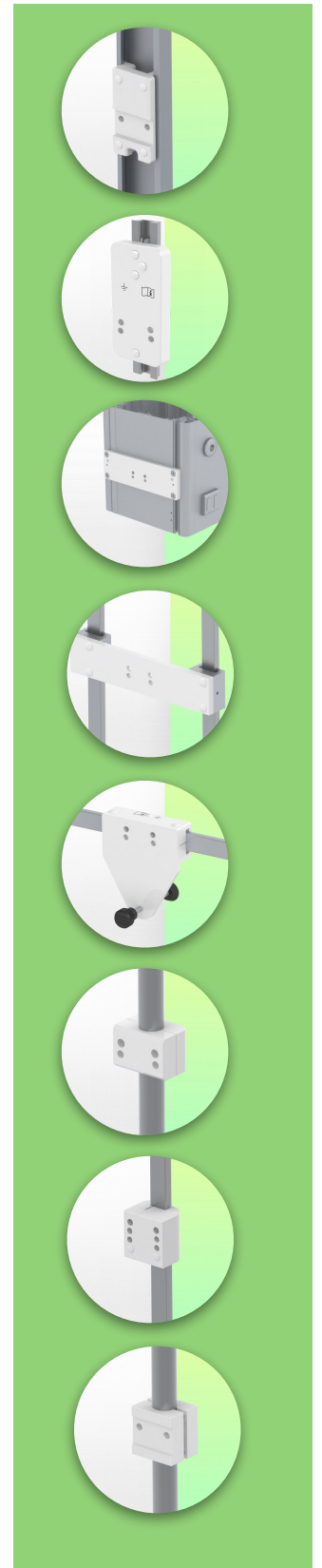
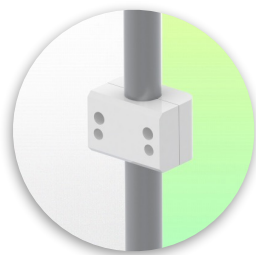
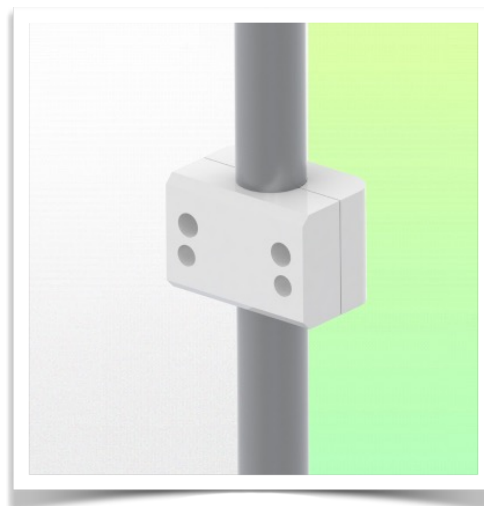

**Presentation**

**Part Number: WM 260.200X**

**Extended Height Adjustable Medical Arm 808 mm, for monitoring Philips Intellivue MP2/X2/X3 Séries, Mounting on fixed pole diameter 25, 35 and 38 mm. Supported weight balancing range from 0 to 3,5 Kg. mounting without power cable hook**

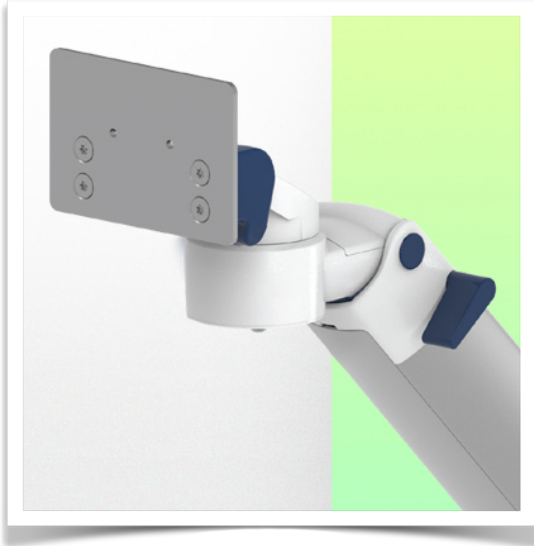

**Philips Intellivue-serie MP2/X2/X3  
bewakingsadapter**

Al onze medische armen kunnen worden uitgerust met deze aanpassing, waarvan hier enkele afbeeldingen worden getoond.

