

Presentation

Part Number: WM 260.205

Extended Height Adjustable Arm 761 mm, for monitoring Philips Intellivue Séries, Variable Pole Mount from 23 to 40 mm. Supported weight balancing range from 2 to 5 Kg.

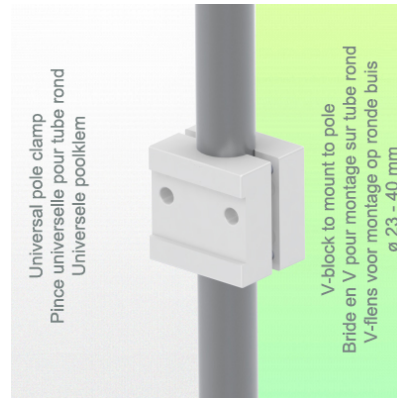
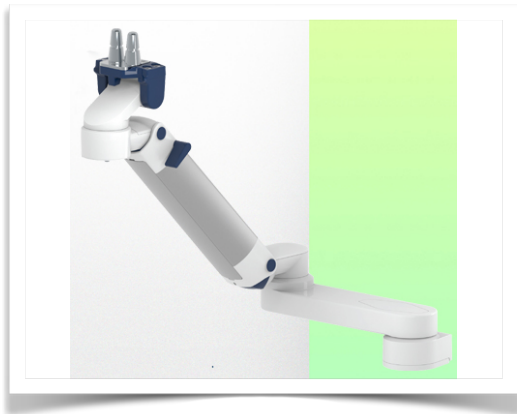

Extended Height Adjustable Arm 761 mm, for monitoring Philips Intellivue Séries, Variable Pole Mount from 23 to 40 mm. Supported weight balancing range from 2 to 5 Kg.

Full cable integration and infection prevention thanks to easy-to-clean surfaces make this arm ideal for emergency care areas. Height adjustment for ergonomic, customised positioning of the monitor. This Horizontal Double Medical Arm with gas-lift height adjustment enables the monitor to be fixed, oriented and adjusted perfectly. It is coated with an anti-microbial agent for hygiene and cleaning down to the smallest detail. Its modern design has been specially developed for healthcare environments.

Technical specifications:

* Integrated cable passage * Equipotential bonding * Fixing on the chosen adapter solution* This gas-operated Double Arm simply slides into the column rail, then adjusts to the required height and locks into place. It has a safety stop button for height adjustment, which allows the arm to remain in the chosen position. * The head of this arm is fitted for Philips Intellivue Series Monitors * Compatible with monitors weighing no more than 2-5 Kg * Monitor tilt: 21° down and 20° up * Screen rotation: 130° right, 180° left. * Arm rotation: 90° right, 90° left * Height adjustment: 438 mm * Total length 761 mm * All our medical arms comply with CE, ROHS, Medical Grade, Regulations MDD 93/42 ECC. * Colour: RAL 5013 cobalt blue and RAL 9016 traffic white * Warranty: 5 years

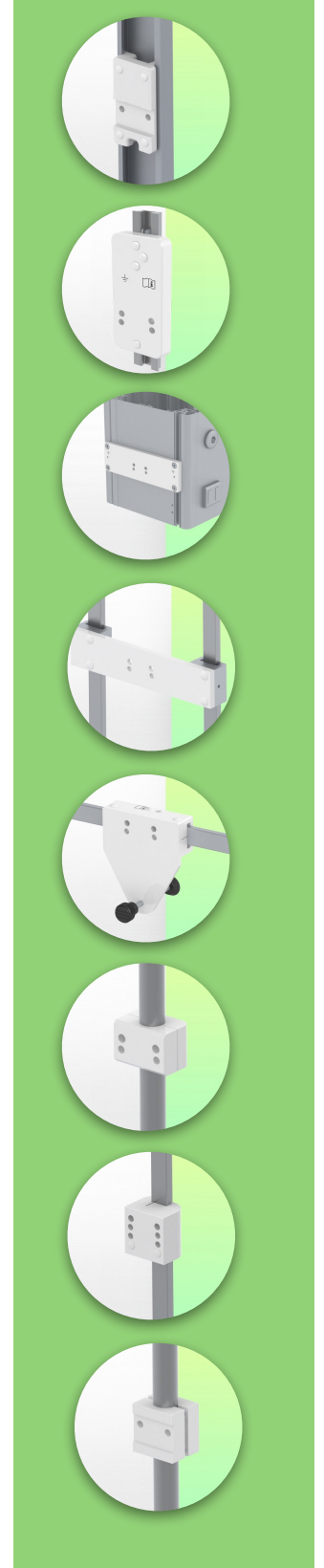

Technical specifications

Part Number: WM 260.205

Extended Height Adjustable Arm 761 mm, for monitoring Philips Intellivue Séries, Variable Pole Mount from 23 to 40 mm. Supported weight balancing range from 2 to 5 Kg.

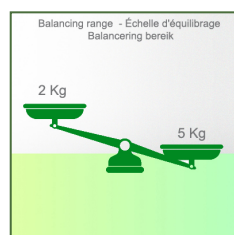
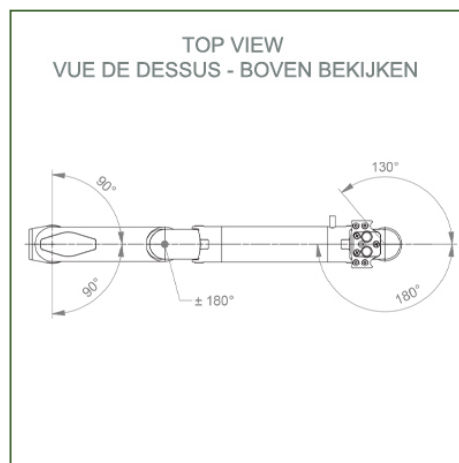
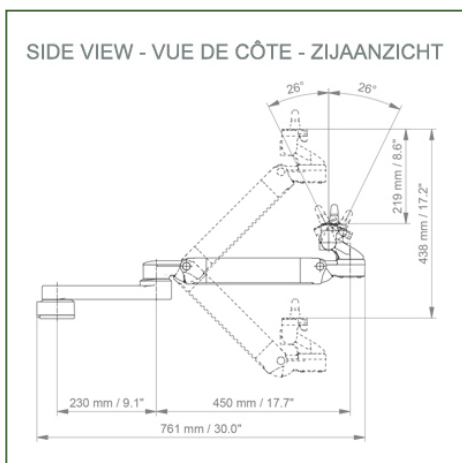
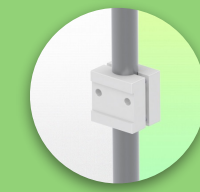
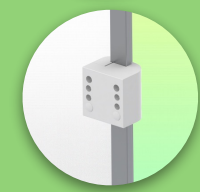
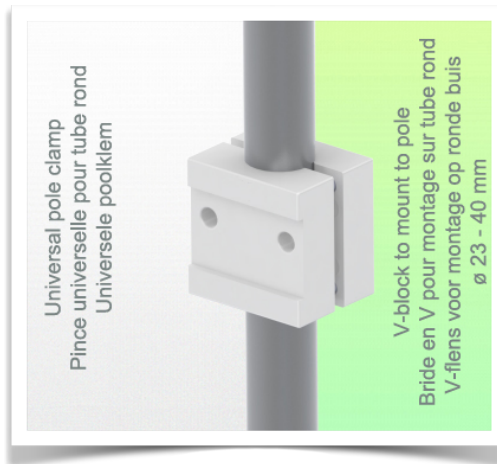
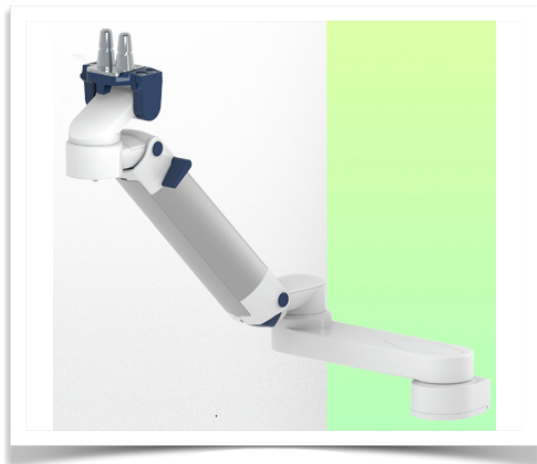

Monitor adaptation: Philips Intellivue Series
Colour: Decorative parts: RAL 5013 cobalt blue
Aluminium parts: RAL 9016 traffic white
Max. load capacity of support arm: 22 kg
Max. load monitor adaptation: 18 Kg
Balancing scale for this medical arm: 2 - 5 Kg
Product weight: 4,9 Kg

Height adjustment: parallel mechanism for a constant viewing angle

Safety: Has a safety stop button for height adjustment, allowing the medical arm to remain in the chosen position.

Installation information - Adapter Variable Pole Clamp

Part Number: WM 260.205

Extended Height Adjustable Arm 761 mm, for monitoring Philips Intellivue Séries, Variable Pole Mount from 23 to 40 mm. Supported weight balancing range from 2 to 5 Kg.

Fixed pole variable clamp:

To mount to pole \varnothing 23 - 40 mm

* Please specify the diameter of the Pole when ordering.

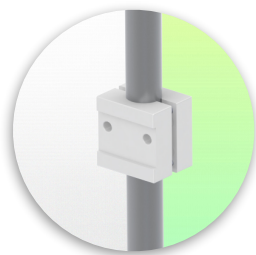
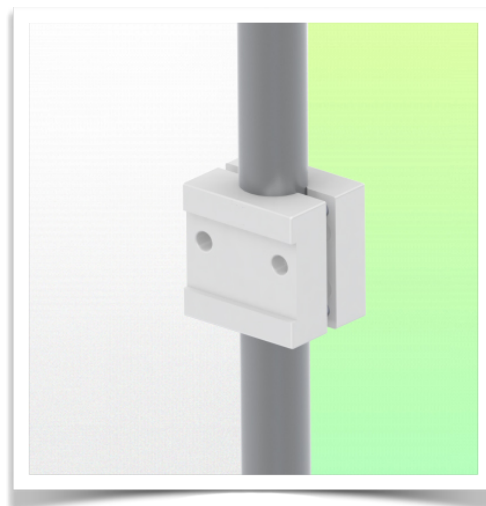
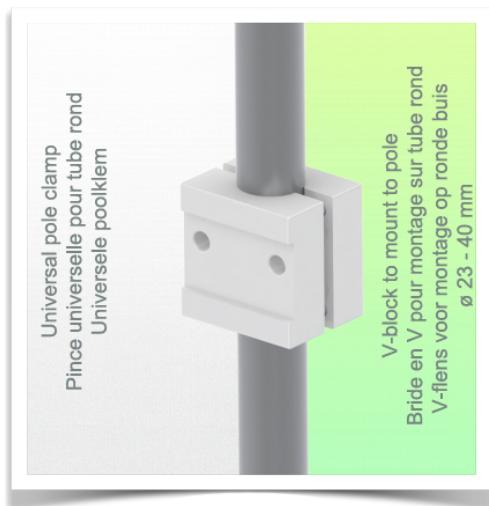

Presentation

Part Number: WM 260.205

Extended Height Adjustable Arm 761 mm, for monitoring Philips Intellivue Séries, Variable Pole Mount from 23 to 40 mm. Supported weight balancing range from 2 to 5 Kg.

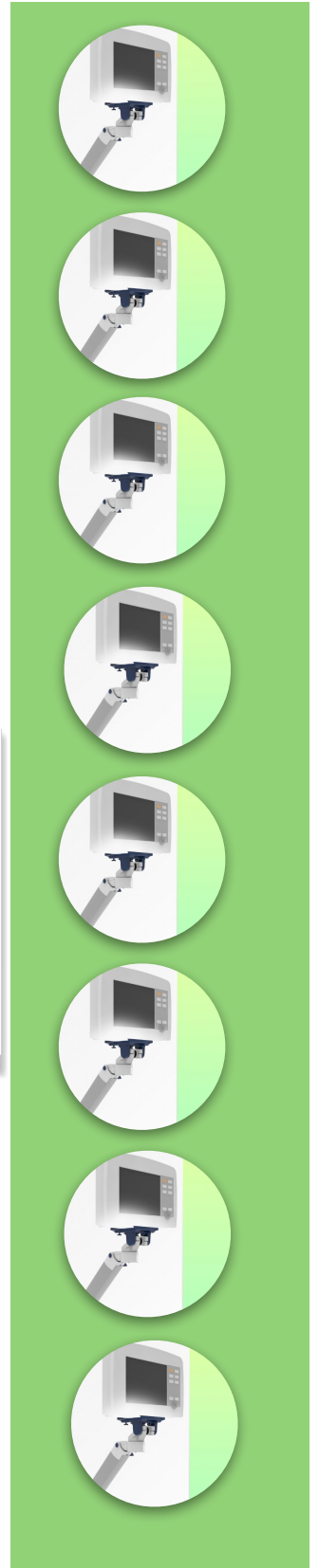

Adaptation monitoring Philips Intellivue series

All our medical arms can be fitted with this adaptation, some illustrations of which can be found here.

