

Presentation

Part Number: WM 260.225X

Extended Height Adjustable Medical Arm 808 mm, for monitoring Philips Intellivue MP2/X2/X3 Séries, Mounting on Mindray Medical Power Supply Device. Supported weight balancing range from 0 to 3,5 Kg. mounting without power cable hook

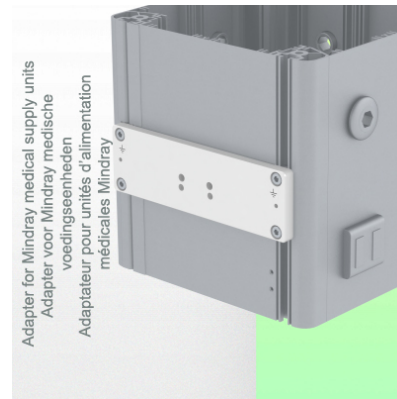
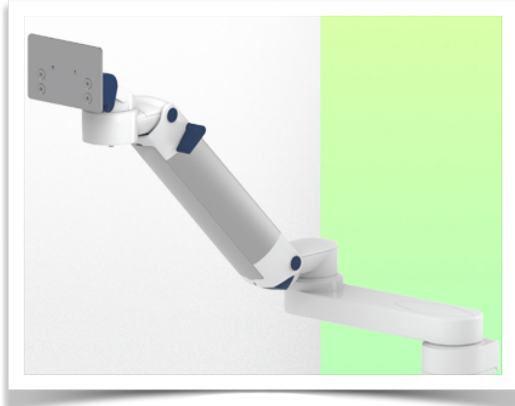

Extended Height Adjustable Medical Arm 808 mm, for monitoring Philips Intellivue MP2/X2/X3 Séries, Mounting on Mindray Medical Power Supply Device. Supported weight balancing range from 0 to 3,5 Kg. mounting without power cable hook

Full cable integration and infection prevention thanks to easy-to-clean surfaces make this arm ideal for emergency care areas. Height adjustment for ergonomic, customised positioning of the monitor. This Horizontal Double Medical Arm with gas-lift height adjustment enables the monitor to be fixed, oriented and adjusted perfectly. It is coated with an anti-microbial agent for hygiene and cleaning down to the smallest detail. Its modern design has been specially developed for healthcare environments.

Technical specifications:

- * Integrated cable passage * Equipotential bonding * Fixing on the chosen adapter solution* This gas-operated Double Arm simply slides into the column rail, then adjusts to the required height and locks into place. It has a safety stop button for height adjustment, which allows the arm to remain in the chosen position.
- * The head of this arm is fitted for Philips Intellivue MP2/X2/X3 series monitors
- * Compatible with monitors weighing no more than 0-3,5 Kg
- * Monitor tilt: 30° down and 20° up * Screen rotation: 135° right, 180° left.
- * Arm rotation: 90° right, 90° left * Height adjustment: 438 mm
- * Total length 808 mm * All our medical arms comply with CE, ROHS, Medical Grade, Regulations MDD 93/42 ECC. * Colour: RAL 5013 cobalt blue and RAL 9016 traffic white * Warranty: 5 years

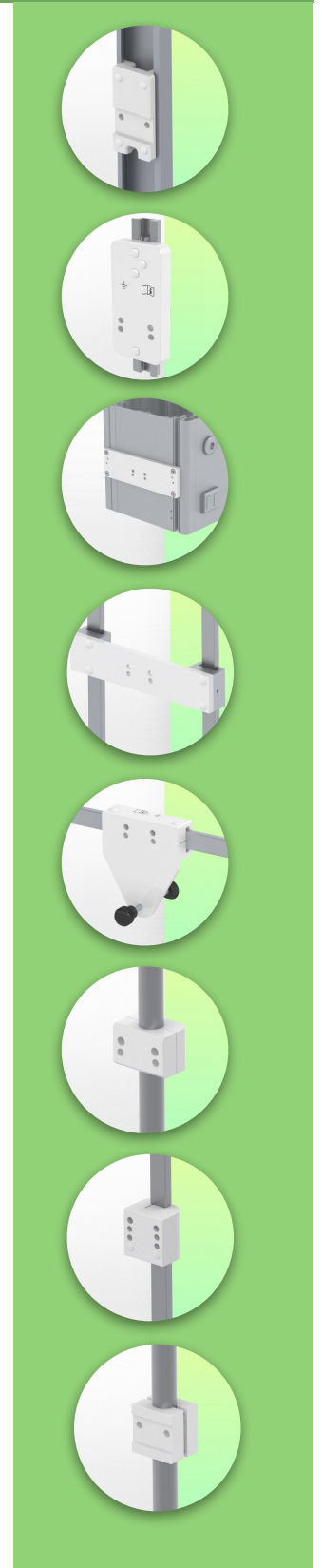

Technical specifications

Part Number: WM 260.225X

Extended Height Adjustable Medical Arm 808 mm, for monitoring Philips Intellivue MP2/X2/X3 Séries, Mounting on Mindray Medical Power Supply Device. Supported weight balancing range from 0 to 3,5 Kg. mounting without power cable hook

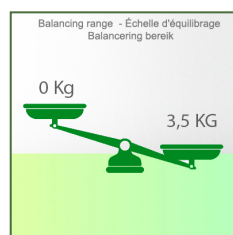
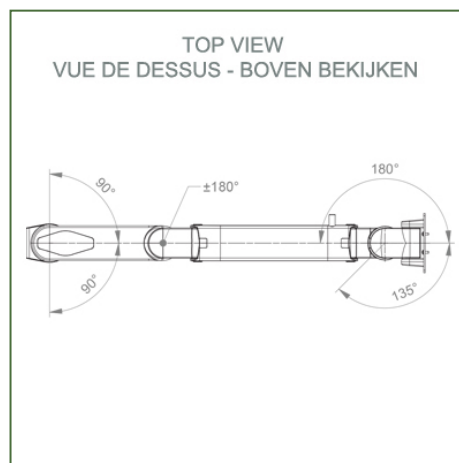
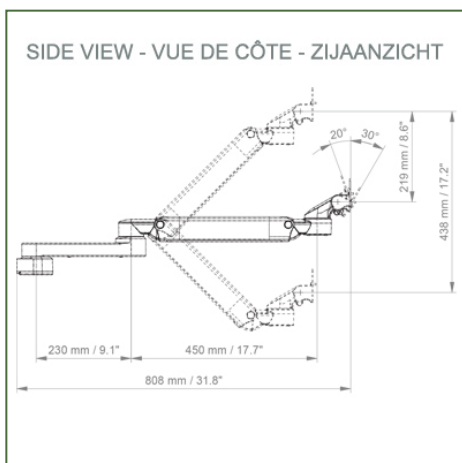
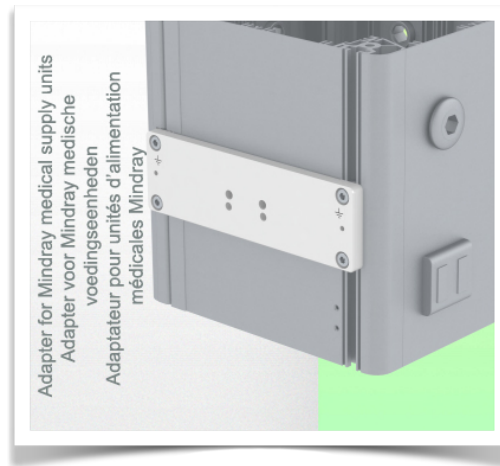
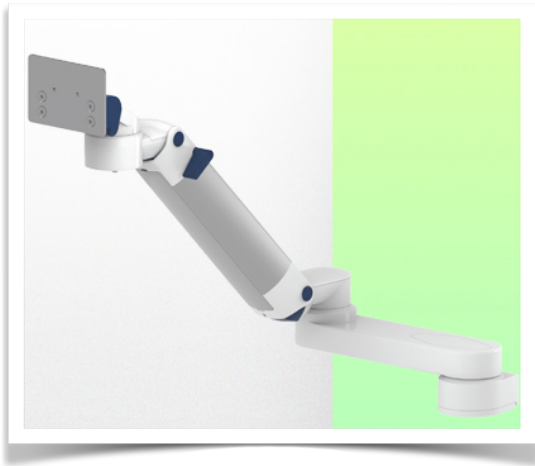

Monitor adaptation: Philips Intellivue MP2/X2/X3 Series

Colour: Decorative parts: RAL 5013 cobalt blue

Aluminium parts: RAL 9016 traffic white

Max. load capacity of support arm: 22 kg

Max. load monitor adaptation: 18 Kg

Balancing scale for this medical arm: 0 - 3,5 Kg

Product weight: 4,5 Kg

Height adjustment: parallel mechanism for a constant viewing angle

Safety: Has a safety stop button for height adjustment, allowing the medical arm to remain in the chosen position.

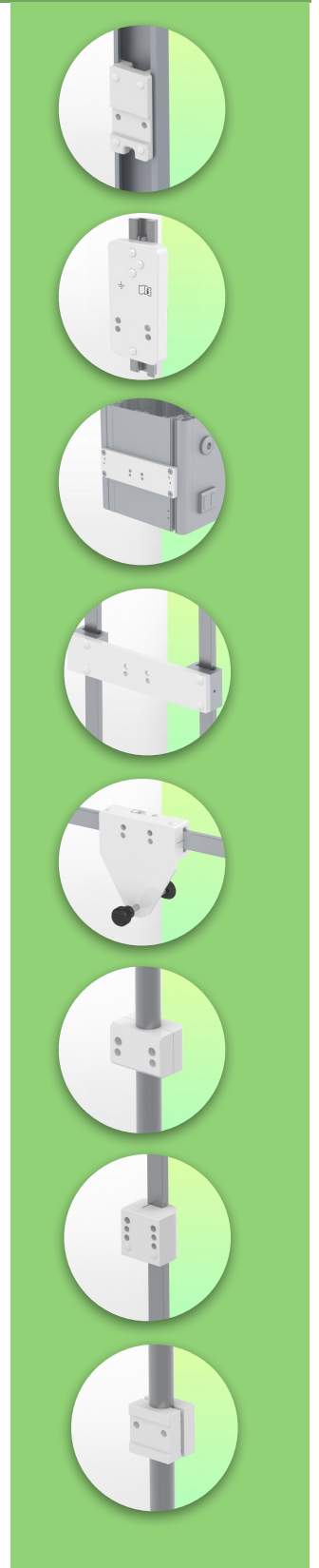

Installation information - Adapter Mindray

Part Number: WM 260.225X

Extended Height Adjustable Medical Arm 808 mm, for monitoring Philips Intellivue MP2/X2/X3 Séries, Mounting on Mindray Medical Power Supply Device. Supported weight balancing range from 0 to 3,5 Kg. mounting without power cable hook

Adapter Mindray:

Mounting on Mindray Medical Supply Device

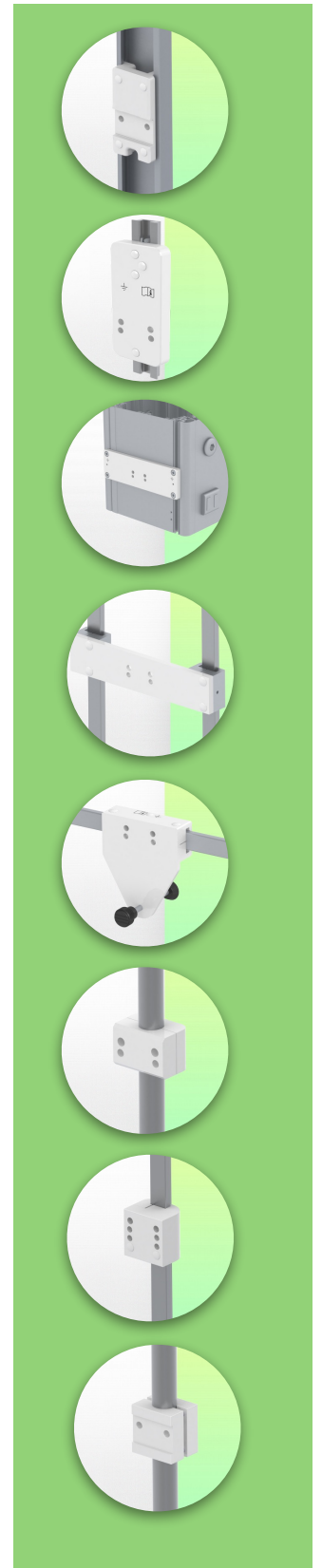
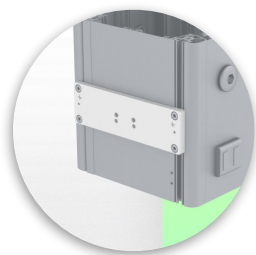
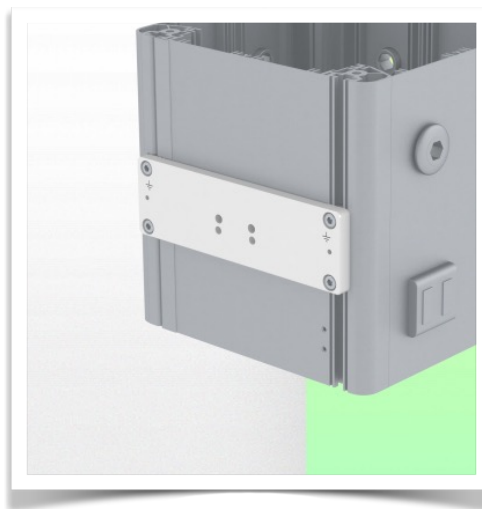
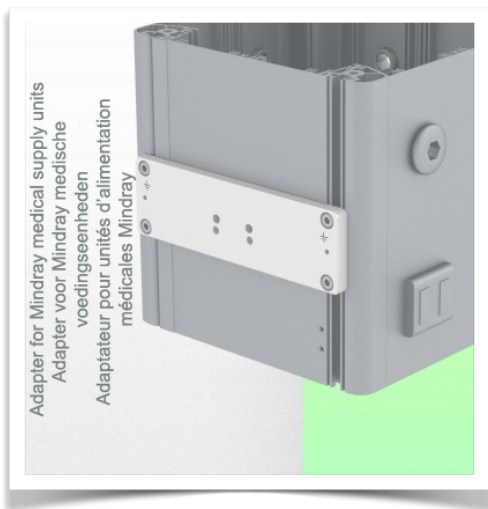

Presentation

Part Number: WM 260.225X

Extended Height Adjustable Medical Arm 808 mm, for monitoring Philips Intellivue MP2/X2/X3 Séries, Mounting on Mindray Medical Power Supply Device. Supported weight balancing range from 0 to 3,5 Kg. mounting without power cable hook

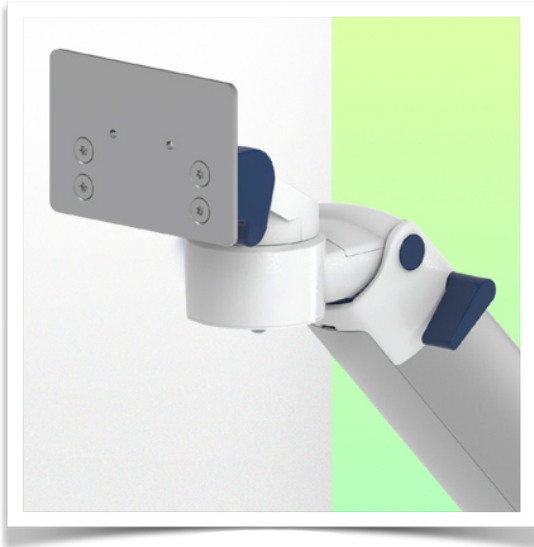

Adaptation monitoring Philips Intellivue MP2 / X2 / X3 series

All our medical arms can be fitted with this adaptation, some illustrations of which can be found here.

