

Presentation

Part Number: WM 260.235X

Extended Height Adjustable Medical Arm 808 mm, for monitoring Philips Intellivue MP2/X2/X3 Séries, Mounting on Anesthesia Machines (All manufacturers). Supported weight balancing range from 0 to 3,5 Kg. mounting without power cable hook

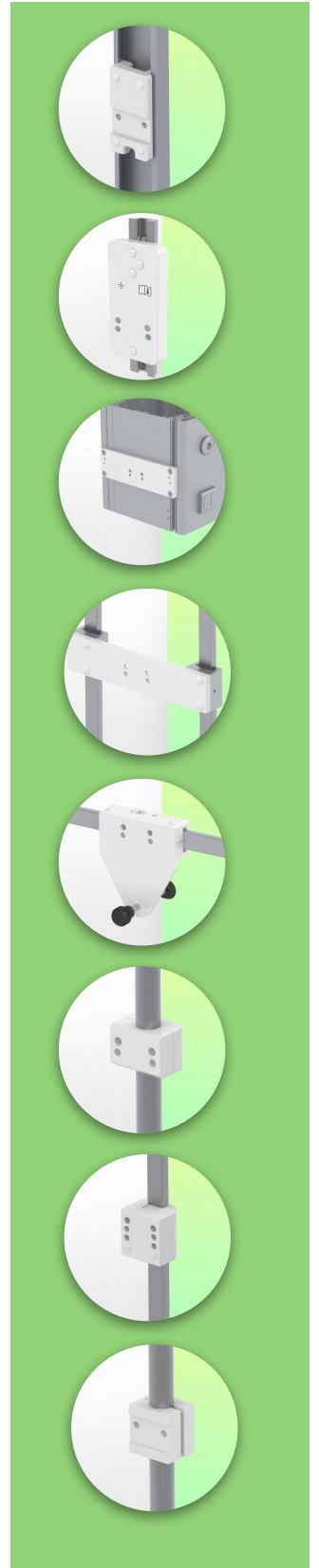
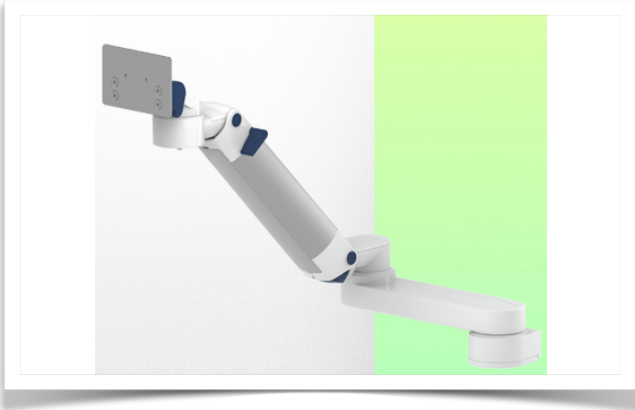

Extended Height Adjustable Medical Arm 808 mm, for monitoring Philips Intellivue MP2/X2/X3 Séries, Mounting on Anesthesia Machines (All manufacturers). Supported weight balancing range from 0 to 3,5 Kg. mounting without power cable hook

Full cable integration and infection prevention thanks to easy-to-clean surfaces make this arm ideal for emergency care areas. Height adjustment for ergonomic, customised positioning of the monitor. This 808 mm Horizontal Medical Arm with gas-lift height adjustment enables the monitor to be fixed, oriented and adjusted perfectly. It is coated with an anti-microbial agent for hygiene and cleaning down to the smallest detail. Its modern design has been specially developed for healthcare environments.

Technical specifications:

- * Integral cable entry * Equipotential bonding * This 808 mm Horizontal Extended Arm with gas spring simply adjusts to the desired height and is fixed. It has a safety stop button for height adjustment, allowing the arm to remain in the chosen position. * The head of this arm is compatible with Philips Intellivue MP2/X2/X3 Series monitors.* Suitable for monitors weighing up to 0-3,5 Kg.
- * Monitor tilt: 30° down and 20° up * Monitor rotation: 135° right, 180° left.
- * Arm rotation: 90° right, 90° left * Height adjustment: 438 mm
- * Total length: 808 mm * All our medical arms comply with CE, ROHS, Medical Grade, Regulations MDD 93/42 ECC. * Colour: RAL 5013 cobalt blue and RAL 9016 traffic white * Warranty: 5 years

Technical specifications

Part Number: WM 260.235X

Extended Height Adjustable Medical Arm 808 mm, for monitoring Philips Intellivue MP2/X2/X3 Séries, Mounting on Anesthesia Machines (All manufacturers). Supported weight balancing range from 0 to 3,5 Kg. mounting without power cable hook



SIDE VIEW - VUE DE CÔTE - ZIJAAZICHT

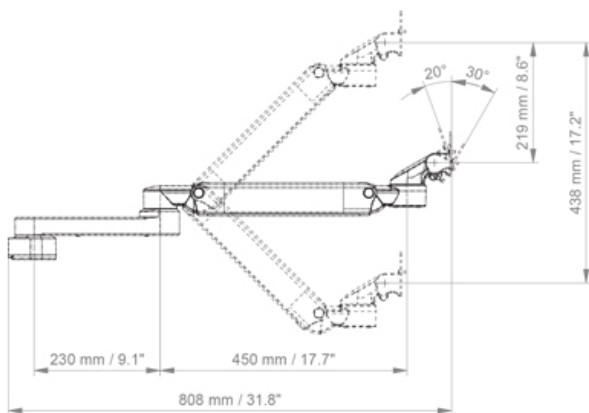

TOP VIEW
VUE DE DESSUS - BOVEN BEKIJKEN

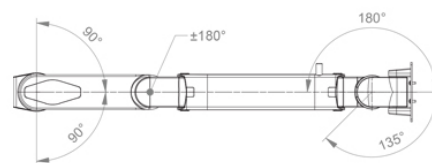

Monitor adaptation: Philips Intellivue MP2/X2/X3 Series

Height adjustment: Slow-release spring, parallel adapter for constant viewing angle

Colour: Decorative parts: RAL 5013 cobalt blue

Aluminium parts: RAL 9016 traffic white

Max. load capacity: 22 kg

Monitor adaptation max. load: 18 Kg

Balance scale on this medical arm: 0 - 3,5 Kg

Product weight: 4.5 Kg

Safety: Has a safety stop button for height adjustment, which allows the medical arm to remain in the chosen position.

Compatibility: Monitoring Philips Intellivue Series

Presentation

Part Number: WM 260.235X

Extended Height Adjustable Medical Arm 808 mm, for monitoring Philips Intellivue MP2/X2/X3 Séries, Mounting on Anesthesia Machines (All manufacturers). Supported weight balancing range from 0 to 3,5 Kg. mounting without power cable hook

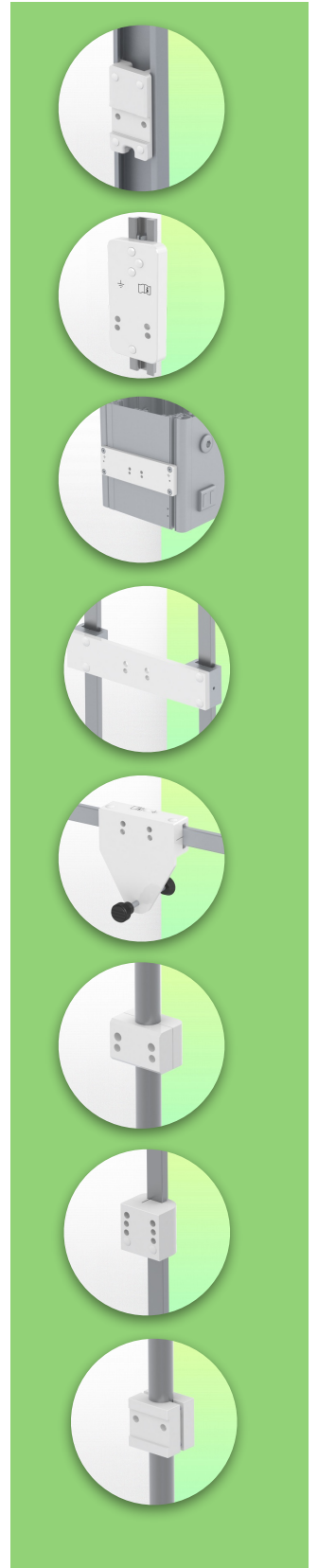
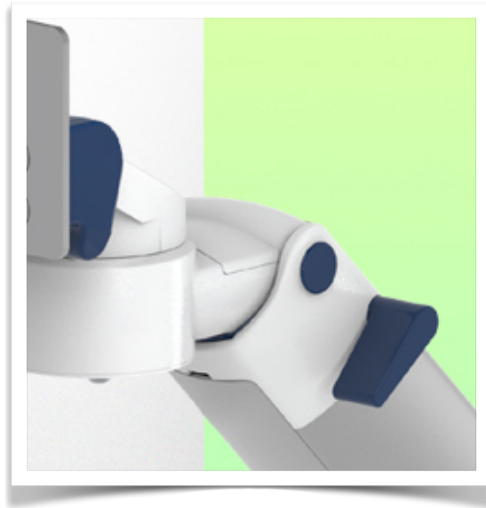
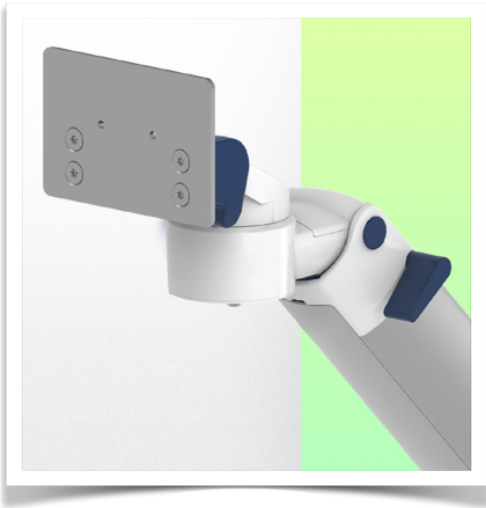

Installation information - Adapter Amico

Part Number: WM 260.235X

Extended Height Adjustable Medical Arm 808 mm, for monitoring Philips Intellivue MP2/X2/X3 Séries, Mounting on Anesthesia Machines (All manufacturers). Supported weight balancing range from 0 to 3,5 Kg. mounting without power cable hook

Adapter Anesthesia Machines (All Manufacturers):

Mounting on Anesthesia Machines (All Manufacturers)

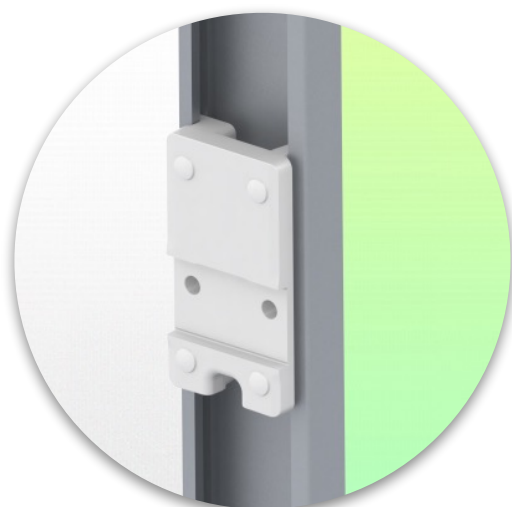

Presentation

Part Number: WM 260.235X

Extended Height Adjustable Medical Arm 808 mm, for monitoring Philips Intellivue MP2/X2/X3 Séries, Mounting on Anesthesia Machines (All manufacturers). Supported weight balancing range from 0 to 3,5 Kg. mounting without power cable hook

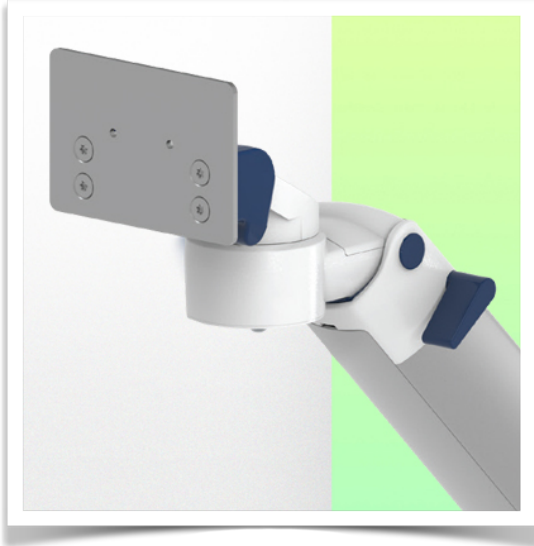

Adaptation monitoring Philips Intellivue MP2 / X2 / X3 series

All our medical arms can be fitted with this adaptation, some illustrations of which can be found here.

