

Presentation

Part Number: WM 260.324

Extended Height Adjustable Arm for monitoring Philips Intellivue Séries, Variable Pole Mount from 23 to 40 mm. Supported weight balancing range from 16 to 22 Kg. Overhead mount

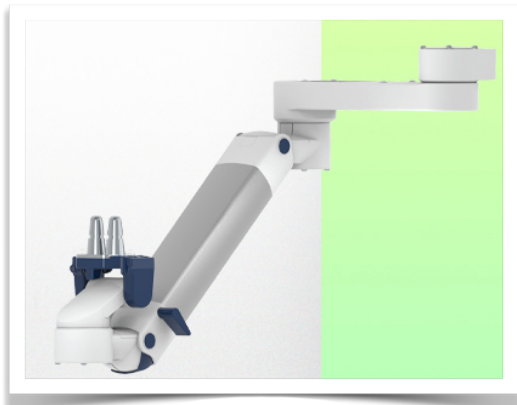

Extended Height Adjustable Arm for monitoring Philips Intellivue Séries, Variable Pole Mount from 23 to 40 mm. Supported weight balancing range from 16 to 22 Kg. Overhead mount

Full cable integration and infection prevention thanks to easy-to-clean surfaces make this arm ideal for emergency care areas. Height adjustment for ergonomic, customised positioning of the monitor. This Horizontal Double Medical Arm with gas-lift height adjustment enables the monitor to be fixed, oriented and adjusted perfectly. It is coated with an anti-microbial agent for hygiene and cleaning down to the smallest detail. Its modern design has been specially developed for healthcare environments.

Technical specifications:

- * Integrated cable passage
- * Equipotential bonding
- * Fixing on the chosen adapter solution
- * This gas-operated Double Arm simply slides into the column rail, then adjusts to the required height and locks into place. It has a safety stop button for height adjustment, which allows the arm to remain in the chosen position.
- * The head of this arm is fitted for Philips Intellivue Series monitors
- * Compatible with monitors weighing no more than 16-22 Kg
- * Monitor tilt: 21° down and 20° up
- * Screen rotation: 130° right, 180° left.
- * Arm rotation: 90° right, 90° left
- * Height adjustment: 438 mm
- * Total length 761 mm
- * All our medical arms comply with CE, ROHS, Medical Grade, Regulations MDD 93/42 ECC.
- * Colour: RAL 5013 cobalt blue and RAL 9016 traffic white
- * Warranty: 5 years

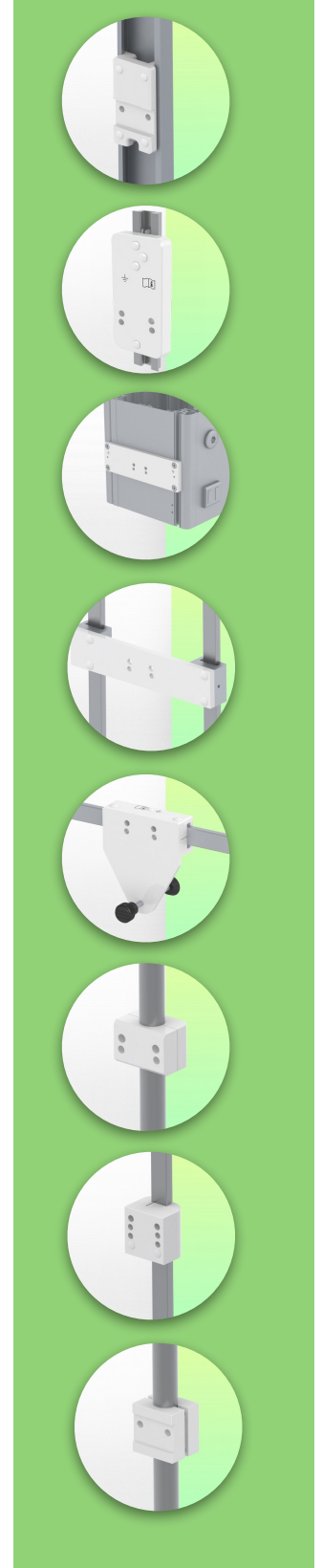

Technical specifications

Part Number: WM 260.324

Extended Height Adjustable Arm for monitoring Philips Intellivue Séries, Variable Pole Mount from 23 to 40 mm. Supported weight balancing range from 16 to 22 Kg. Overhead mount

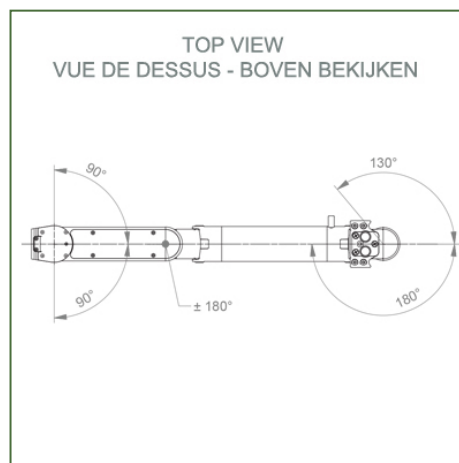

Monitor adaptation: Philips Intellivue Series

Colour: Decorative parts: RAL 5013 cobalt blue

Aluminium parts: RAL 9016 traffic white

Max. load capacity of support arm: 22 kg

Max. load monitor adaptation: 18 Kg

Balancing scale for this medical arm: 16 - 22 Kg

Product weight: 4,9 Kg

Height adjustment: parallel mechanism for a constant viewing angle

Safety: Has a safety stop button for height adjustment, allowing the medical arm to remain in the chosen position.



Installation information - Adapter Variable Pole Clamp

Part Number: WM 260.324

Extended Height Adjustable Arm for monitoring Philips Intellivue Séries, Variable Pole Mount from 23 to 40 mm. Supported weight balancing range from 16 to 22 Kg. Overhead mount

Fixed pole variable clamp:

To mount to pole \varnothing 23 - 40 mm

* Please specify the diameter of the Pole when ordering.

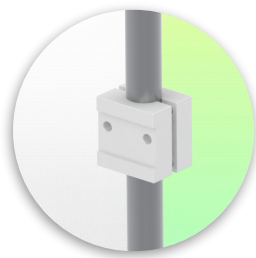
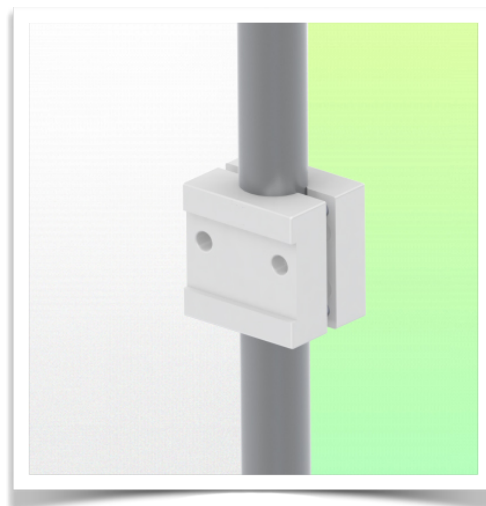
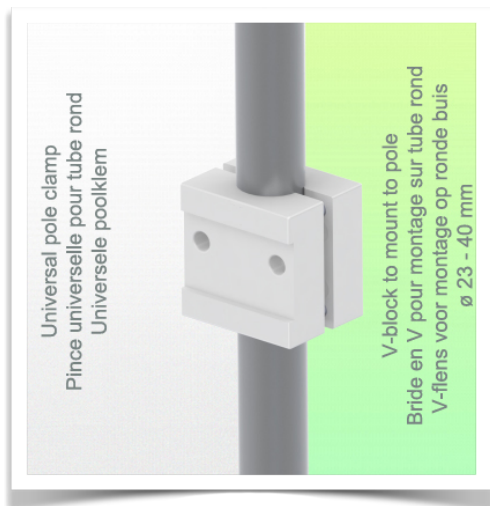

Presentation

Part Number: WM 260.324

Extended Height Adjustable Arm for monitoring Philips Intellivue Séries, Variable Pole Mount from 23 to 40 mm. Supported weight balancing range from 16 to 22 Kg. Overhead mount

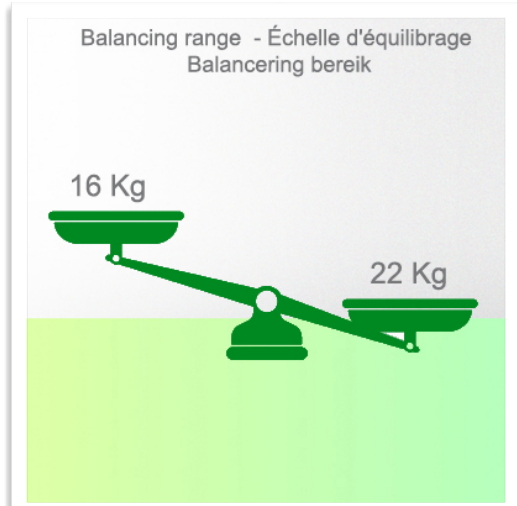

Presentation

Part Number: WM 260.324

Extended Height Adjustable Arm for monitoring Philips Intellivue Séries, Variable Pole Mount from 23 to 40 mm. Supported weight balancing range from 16 to 22 Kg. Overhead mount

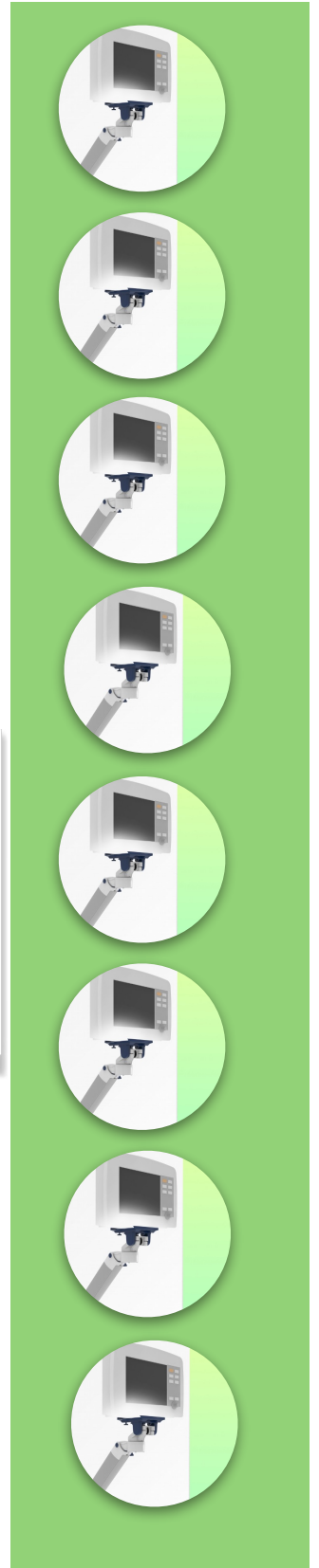
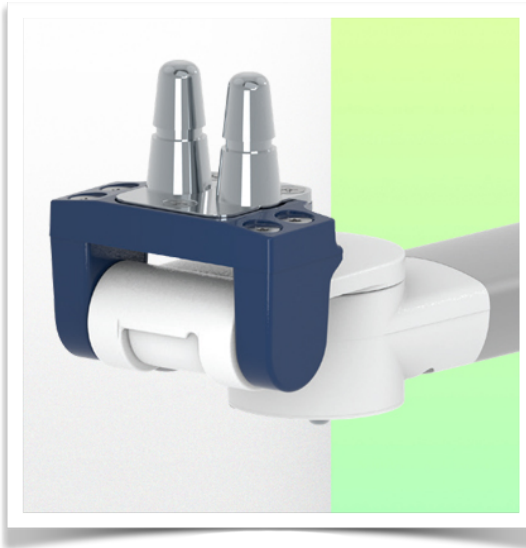
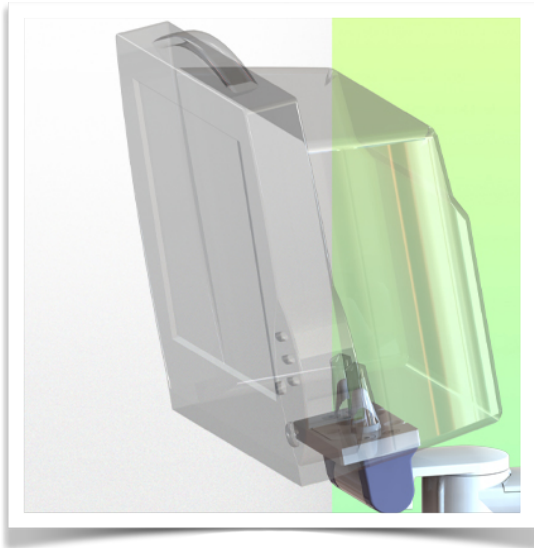

Adaptation monitoring Philips Intellivue series

All our medical arms can be fitted with this adaptation, some illustrations of which can be found here.

