

Presentation

Part Number: WM 280.104

2 x 300 mm Horizontal Medical Arm for Monitoring Philips Intellivue MP2/X2/X3 Séries, floor or ceiling column mounting. mounting with power cable hook

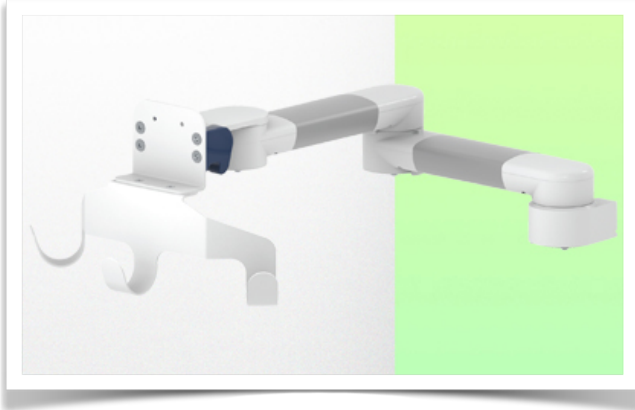

Cette colonne possède deux rails de fixation pour les différents éléments qui y seront fixés. (1 rail à l'avant de la colonne, 1 rail à l'arrière)

This column has two fixing rails for the different elements that will be fixed to it (1 rail at the front of the column, 1 rail at the back)

Deze zuil heeft twee bevestigingsrails voor de verschillende elementen die eraan bevestigd zullen worden (1 rail aan de voorkant van de zuil, 1 rail aan de achterkant)



2 x 300 mm Horizontal Medical Arm for Monitoring Philips Intellivue MP2/X2/X3 Séries, floor or ceiling column mounting. mounting with power cable hook

This 2 x 300 mm Horizontal Arm allows the monitor to be fixed, oriented and adjusted perfectly. It is coated with an anti-microbial agent to ensure hygiene and cleanliness down to the smallest detail. Its modern design has been specially developed for healthcare environments.

Technical specifications:

- * Optional floor or ceiling column mounting, with several heights available (1500 - 2000 mm). These columns can be easily cut to size. All cables are also routed through the column (see options on following pages)
- * This 2 x 300 mm Horizontal Arm simply slides into the column rail and adjusts to the required height. It has no height adjustment
- * The head of this arm complies with the mounting standard for Philips Intellivue MP2/X2/X3 Series monitors weighing up to 8 Kg.
- * Monitor tilt: 23° down and 90° up
- * Monitor rotation: 115° right, 115° left.
- * Arm rotation: 105° right, 105° left.
- * Total length: 691 mm Colour: RAL 5013 cobalt blue and RAL 9016 traffic white
- * Warranty: 5 years

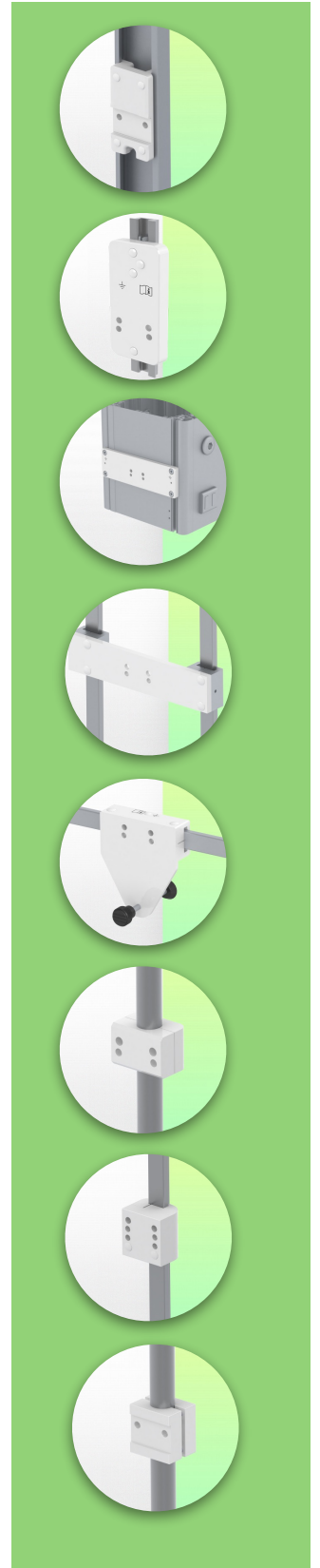

Technical specifications

Part Number: WM 280.104

2 x 300 mm Horizontal Medical Arm for Monitoring Philips Intellivue MP2/X2/X3 Séries, floor or ceiling column mounting. mounting with power cable hook

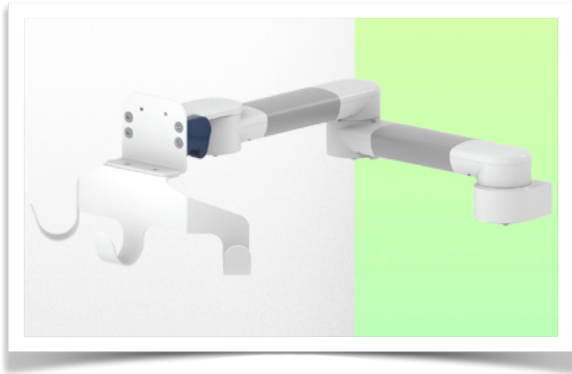

Cette colonne possède deux rails de fixation pour les différents éléments qui y seront fixés. (1 rail à l'avant de la colonne, 1 rail à l'arrière)

This column has two fixing rails for the different elements that will be fixed to it (1 rail at the front of the column, 1 rail at the back)

Deze zuil heeft twee bevestigingsrails voor de verschillende elementen die eraan bevestigd zullen worden (1 rail aan de voorkant van de zuil, 1 rail aan de achterkant)



SIDE VIEW - VUE DE CÔTE - ZIJAAZICHT

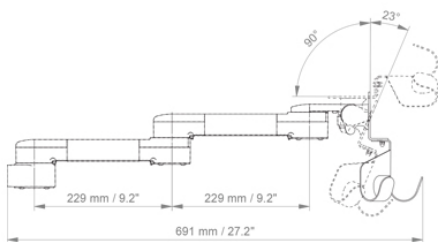

TOP VIEW
VUE DE DESSUS - BOVEN BEKIJKEN

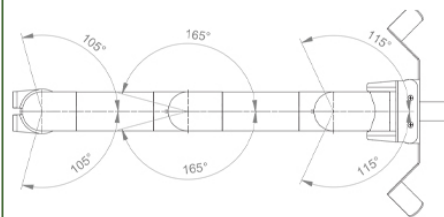

Monitor attachment: Philips Intellivue MP2/X2/X3 Series

Color: Decorative parts: RAL 5013 cobalt blue

Aluminium parts: RAL 9016 traffic white

Max. load capacity of support arm: 8 kg

Monitor attachment max. load capacity: 8 Kg

Product weight: 3,2 Kg

Product highlights:

Non-height adjustable arm. Swivel arms and extended swivel arms offer full cable integration and easy cleaning for infection control in all critical care areas of the clinical environment. Our 5-year guarantee ensures reliable, trouble-free and maintenance-free operation. The swivel function at the point of attachment and the tilt and swivel function of the monitor adaptation provide optimum positioning of your unit. The extended swivel arm is a two-part arm with a central pivot point between the two arm sections. All bottom-mounted monitors have the safety feature of a 20° tilt stop.

Installation information - Column slide rail

Part Number: WM 280.104

2 x 300 mm Horizontal Medical Arm for Monitoring Philips Intellivue MP2/X2/X3 Séries, floor or ceiling column mounting, mounting with power cable hook

Floor or ceiling column:

To install this medical arm, you need to use one of our medical columns. These are available in standard heights of 1500 and 2000 mm. Custom heights are available on request. Slide covers and end caps are supplied with every order.

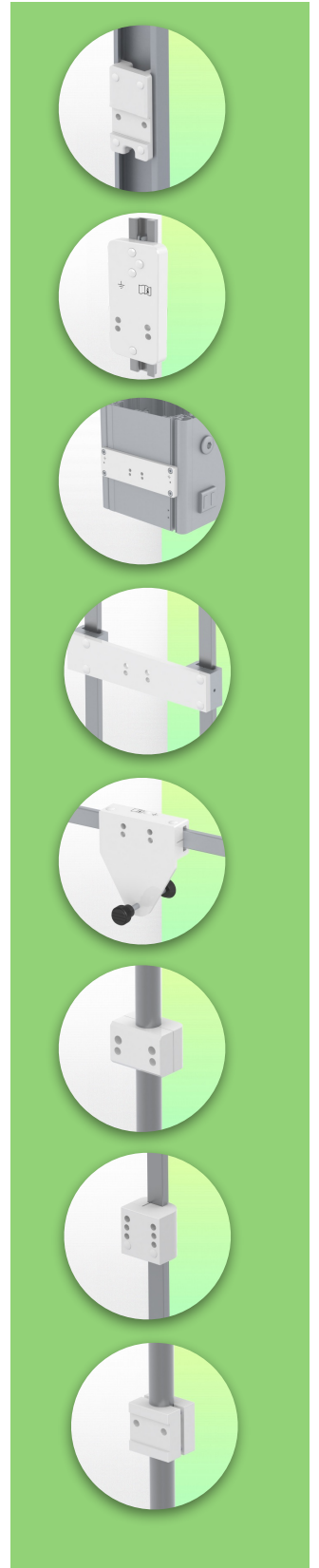
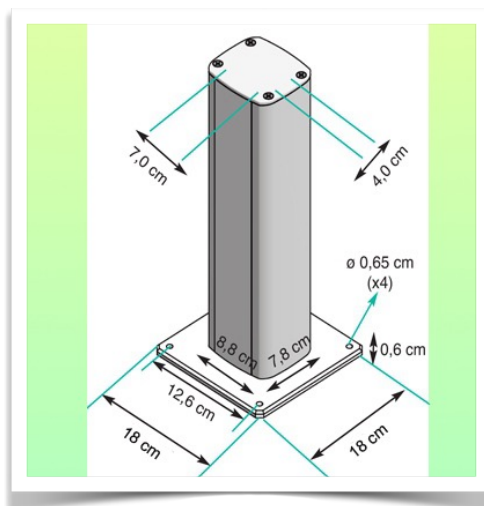
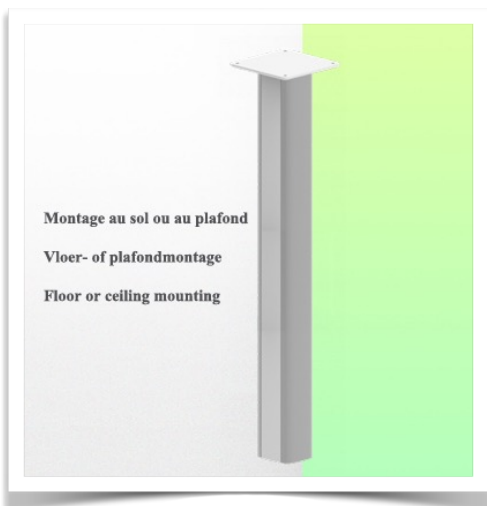
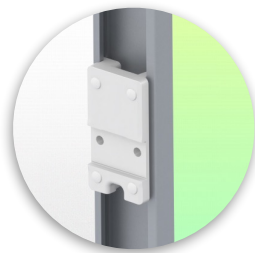
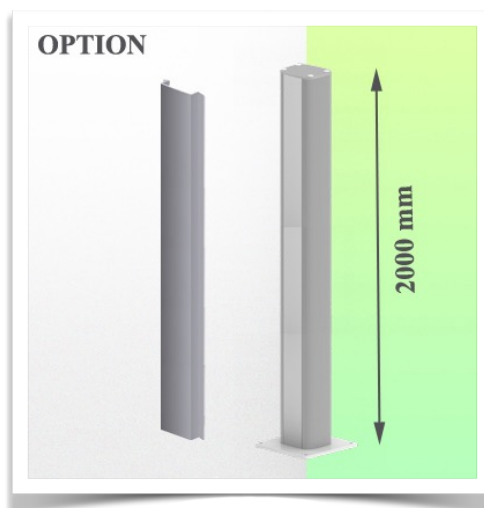
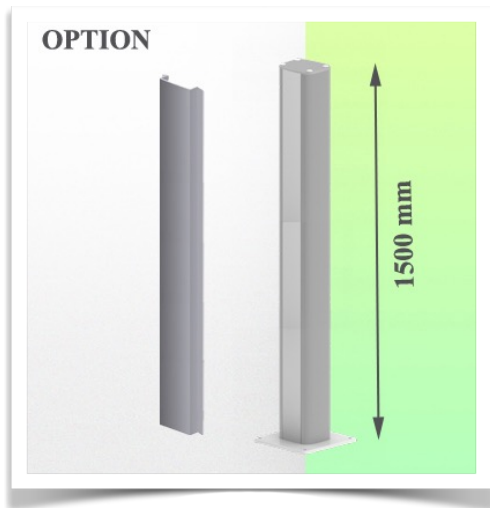

Présentation

Part Number: WM 280.104

2 x 300 mm Horizontal Medical Arm for Monitoring Philips Intellivue MP2/X2/X3 Séries, floor or ceiling column mounting, mounting with power cable hook

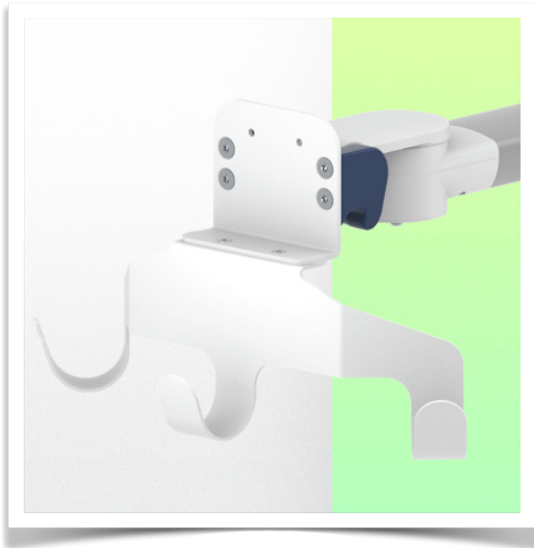

Philips Intellivue MP 2 / X2 / X3 series monitoring adapter

All our medical arms can be fitted with this adaptation, some illustrations of which can be found here

