

Presentation

Part Number: WM 280.125

2 x 300 mm Horizontal Medical Arm for Monitoring Philips Intellivue MP2/X2/X3 Séries, Mounting on Amico medical device pendants and headwalls. mounting with power cable hook

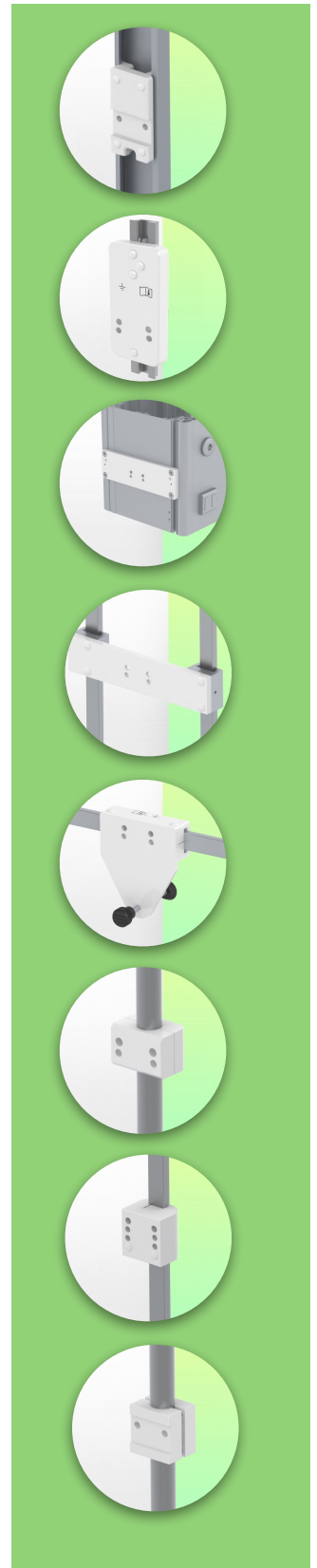
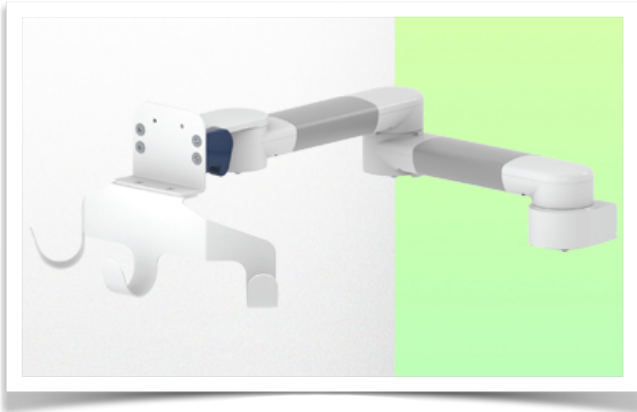

2 x 300 mm Horizontal Medical Arm for Monitoring Philips Intellivue MP2/X2/X3 Séries, Mounting on Amico medical device pendants and headwalls. mounting with power cable hook

This 2 x 300 mm Horizontal Arm allows the monitor to be fixed, oriented and adjusted perfectly. It is coated with an anti-microbial agent to ensure hygiene and cleanliness down to the smallest detail. Its modern design has been specially developed for healthcare environments.

Technical specifications:

- * Integrated cable management
- * Mounting on Amico medical device pendants and headwalls
- * This 2 x 300 mm arm simply attaches to the Amico unit using the adapter and adjusts to the desired height and fixed.. It has no height adjustment.
- * The head of this arm complies with the mounting standard for Philips Intellivue MP2/X2/X3 series monitors weighing up to 8 kg.
- * Monitor tilt: 23° down and 90° up
- * Monitor rotation: 115° right, 115° left.
- * Arm rotation: 105° right, 105° left.
- * Total length: 691 mm Colour: RAL 5013 cobalt blue and RAL 9016 traffic white
- * Warranty: 5 years

Technical specifications

Part Number: WM 280.125

2 x 300 mm Horizontal Medical Arm for Monitoring Philips Intellivue MP2/X2/X3 Séries, Mounting on Amico medical device pendants and headwalls. mounting with power cable hook

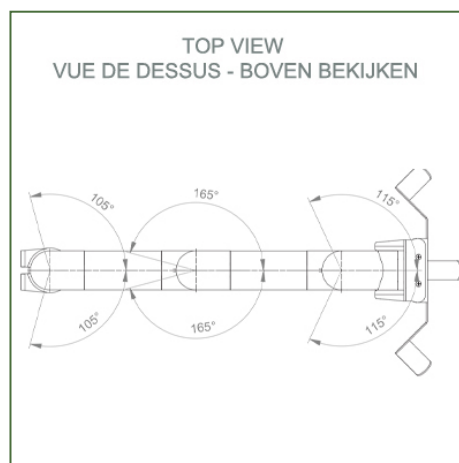
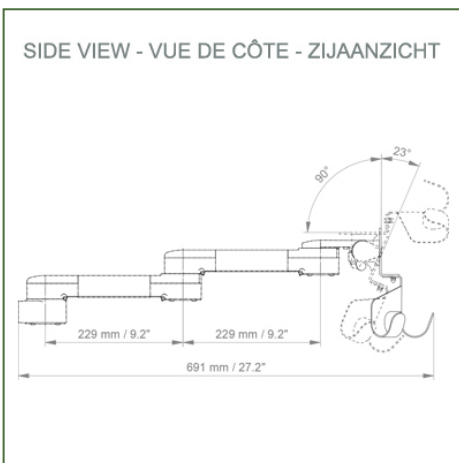
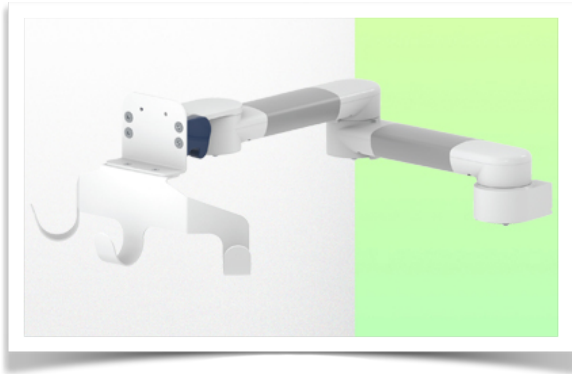

Monitor fitting: Philips Intellivue MP2/X2/X3 series

Colour: Decorative parts: RAL 5013 cobalt blue

Aluminium parts: RAL 9016 traffic white

Max. load capacity of support arm: 8 kg

Monitor fitting max. load: 8 Kg

Product weight: 3,2 Kg

Product strengths:

Non-height-adjustable arm. Swivel arms and extended swivel arms offer full cable integration and easy cleaning for infection control in all critical care areas of the clinical environment. Our 5-year guarantee ensures reliable, trouble-free and maintenance-free operation. The swivel function at the point of attachment and the tilt and swivel function of the monitor adaptation provide optimum positioning of your unit. The extended swivel arm is a two-part arm with a central pivot point between the two arm sections. All bottom-mounted monitors have the safety feature of a 20° tilt stop.

Mounting information - Adapter for Amico

Part Number: WM 280.125

2 x 300 mm Horizontal Medical Arm for Monitoring Philips Intellivue MP2/X2/X3 Séries, Mounting on Amico medical device pendants and headwalls. mounting with power cable hook

Adapter for Amico pendants & headwalls

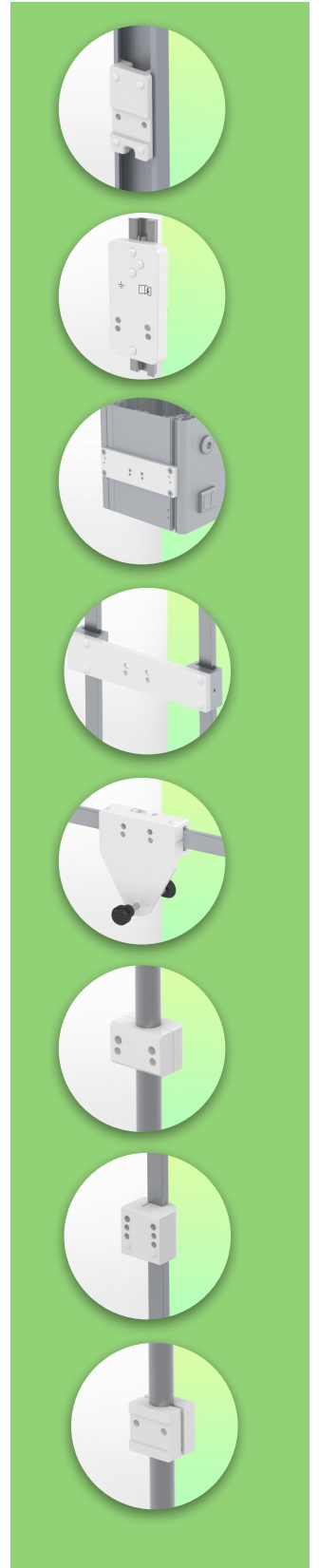
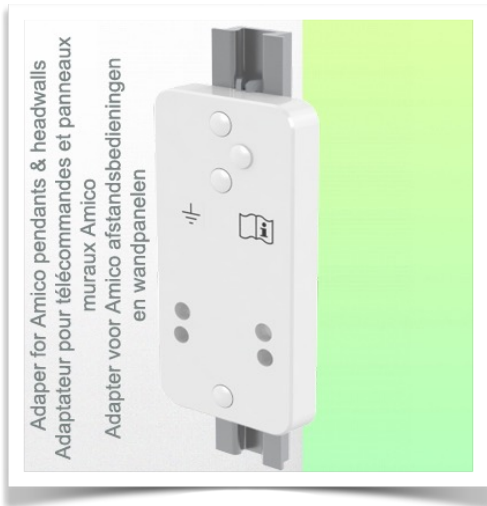

Presentation

Part Number: WM 280.125

2 x 300 mm Horizontal Medical Arm for Monitoring Philips Intellivue MP2/X2/X3 Séries, Mounting on Amico medical device pendants and headwalls. mounting with power cable hook

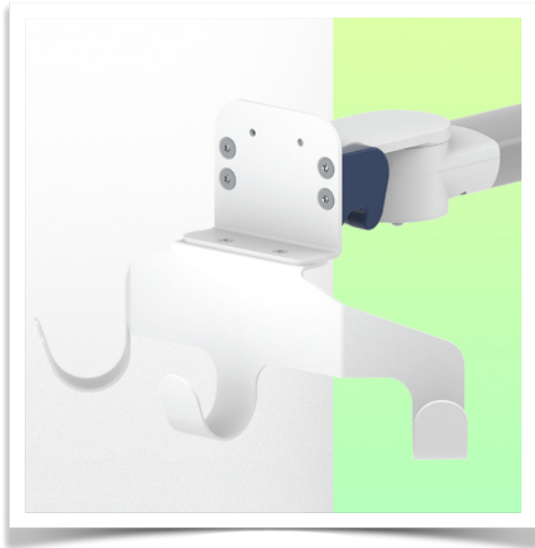

Philips Intellivue MP 2 / X2 / X3 series monitoring adapter

All our medical arms can be fitted with this adaptation, some illustrations of which can be found here

