

Présentation

Part Number: WM 333.106

Medical arm adjustable in height by 300 mm, to be fixed on a work surface or medical cart. Supported weight of balance scale from 9 to 14 Kg

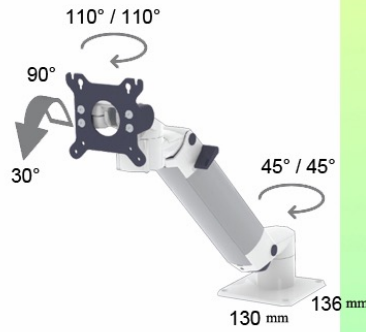
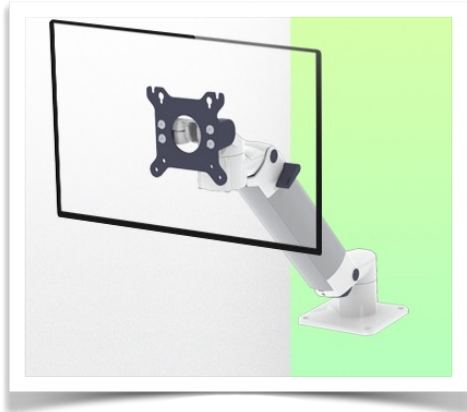

Medical arm adjustable in height by 300 mm, to be fixed on a work surface or medical cart. Supported weight of balance scale from 9 to 14 Kg

Full cable integration and infection prevention through easy-to-clean surfaces make this arm ideal for emergency care areas. Height adjustment for ergonomic and individual positioning of the monitor. This 300 mm Horizontal Medical Arm with gas lift height adjustment allows the monitor to be perfectly fixed, oriented and adjusted. It is coated with an anti-microbial agent to ensure hygiene and cleaning in every detail. Its modern design has been specially developed for healthcare environments.

Technical specifications:

- * The arm has an integrated cable entry * Equipotential bonding
- * Rectangular base with a small footprint of 130 x 136 mm
- * Fixed to the work surface by four screws (\varnothing 0.65 mm x 4)
- * It has a safety stop button for height adjustment, which allows the arm to remain in the chosen position.
- * The head of this arm complies with the VESA MIS-D 75 mm and 100 mm screen mounting standards. * Compatible with screens weighing up to 9-14 Kg.
- * Stability of the touch screen. * Screen tilt: 30° down and 90° up
- * Screen rotation: 130° right, 180° left * Arm rotation: 90° right, 90° left
- * Height adjustment: 45° down, 45° up * Total length 578 mm * All our medical arms are CE, ROHS, Medical Grade, MDD 93/42 ECC compliant. * Colour RAL 5013 cobalt blue and RAL 9016 traffic white * Warranty: 5 years

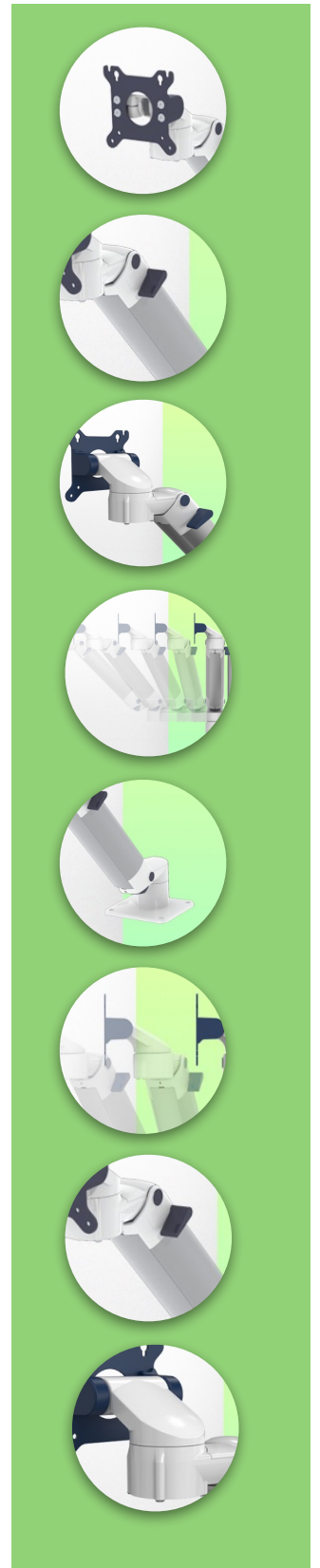

Technical specifications

Part Number: WM 333.106

**Medical arm adjustable in height by 300 mm, to be fixed on a work surface or medical cart.
Supported weight of balance scale from 9 to 14 Kg**

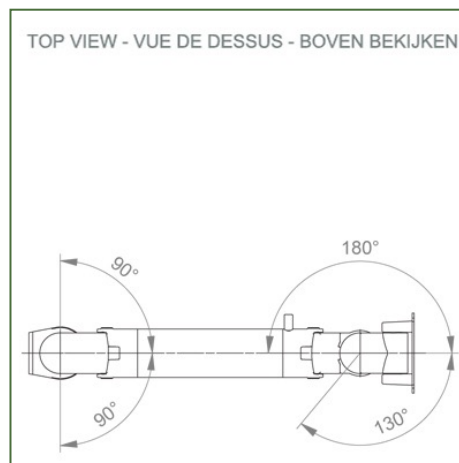
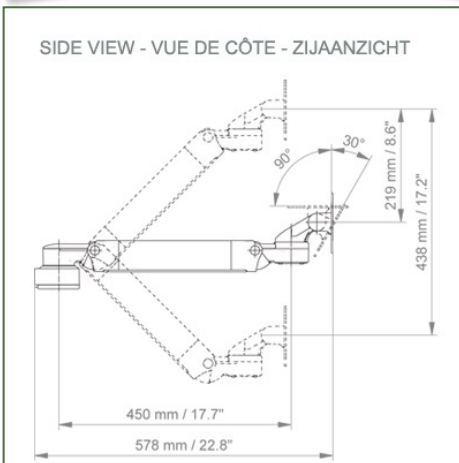
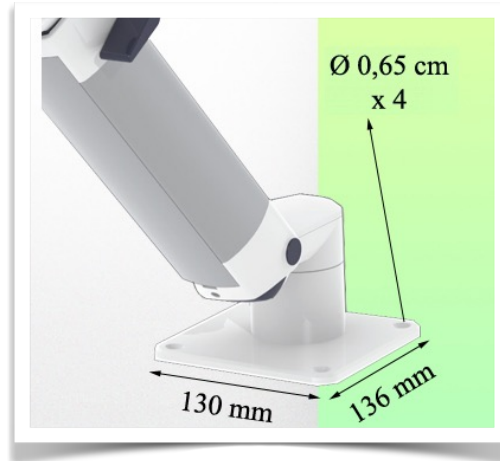
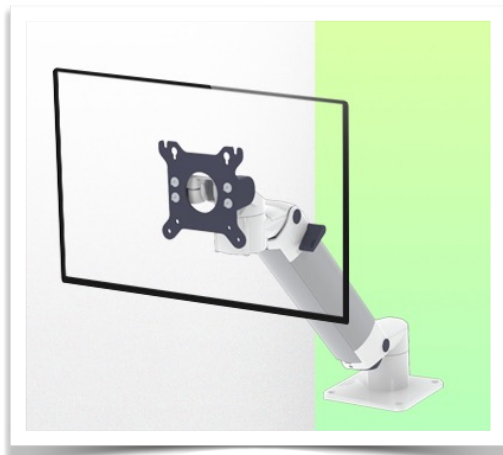

Monitor fitting: VESA 75/100 mm

Colour: Decorative parts: RAL 5013 cobalt blue

Aluminium parts: RAL 9016 traffic white

Balance scale of this medical arm: 9 - 14 Kg

Product weight: 3,3 Kg

Height adjustment: Parallel mechanism for a constant viewing angle

Safety: Has a safety stop button for height adjustment, which allows the medical arm to remain in the chosen position.

