

Presentation

Part Number: WM 334.106

**Medical stand for Vesa 75/100 mm screen to be placed on worktop or medical trolley
Height 340 mm**

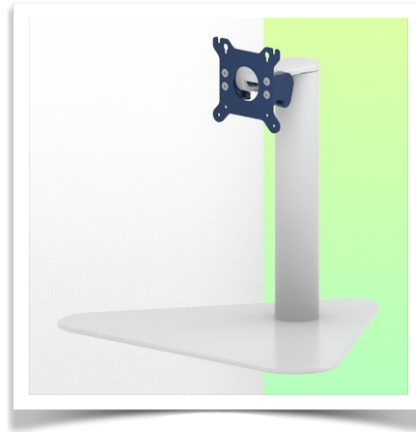

Medical stand for Vesa 75/100 mm screen to be placed on worktop or medical trolley. Height 340 mm

This 340 mm high medical monitor stand allows you to perfectly orient and position your monitor. It is coated with an anti-microbial agent offering hygiene and cleaning in every detail. Easy to install on any surface (work surface, medical trolley). Ideal when you have very little space available for your screen.

Technical specifications:

- * Integrated cable management
- * Free standing trapezoidal design base: 305 x 364 mm
- * Screen mounting standard: VESA MIS-D 75 mm and 100 mm.
- * Compatible with screens weighing up to 18 kg.
- * Touch screen stability.
- * Screen tilt: 90° backwards and 30° forwards
- * Screen head rotation: 35° right, 35° left.
- * Total height with head 398 mm
- * Stand height: 340 mm
- * Compatible with multimedia terminals (TMM)
- * Colour RAL 5013 cobalt blue and RAL 9016 traffic white
- * Warranty: 5 years

Please note: Please check the size of your screen and the available space of the stand in its height when ordering.

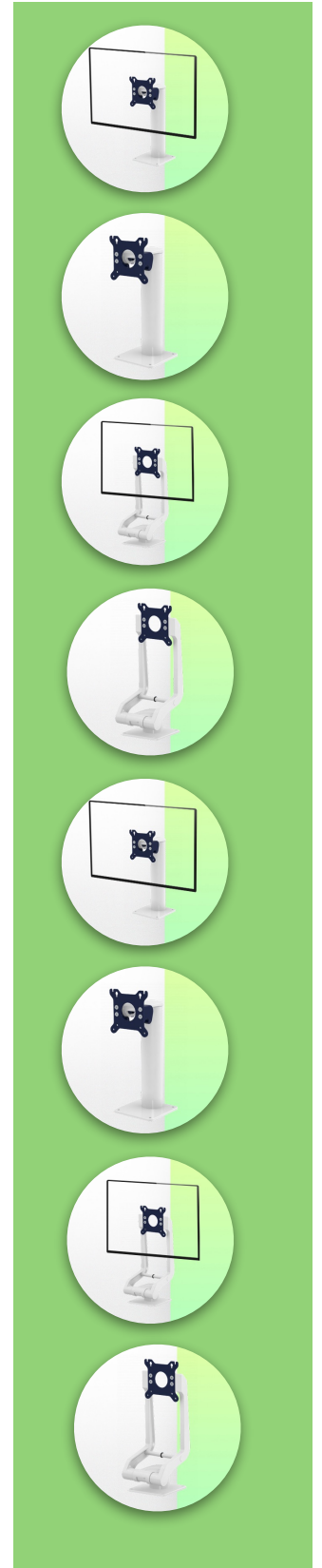

Technical specifications

Part Number: WM 334.106

**Medical stand for Vesa 75/100 mm screen to be placed on worktop or medical trolley
Height 340 mm**

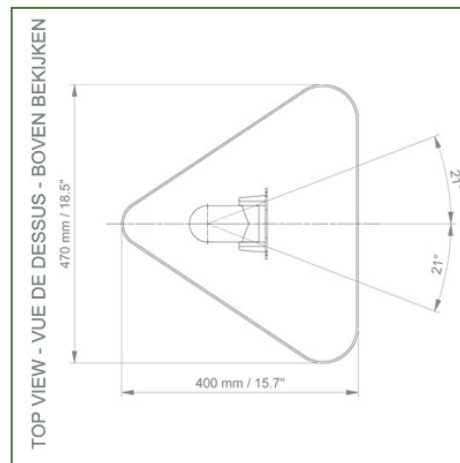
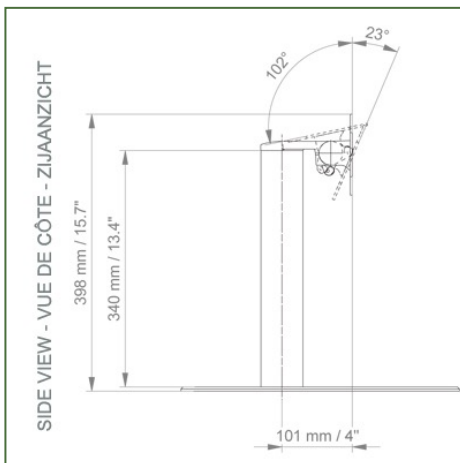
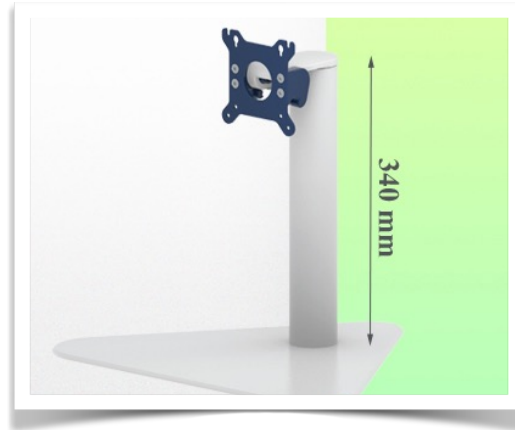
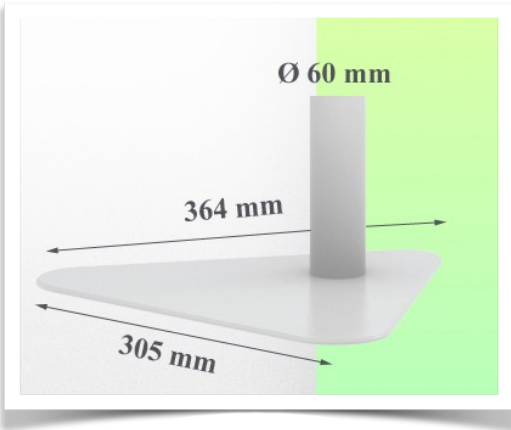

Monitor fitting: VESA 75/100 mm

Colour: Decorative parts: RAL 5013 cobalt blue

Screen compatibility: Up to 26" depending on the exact size of your screen and the available space on the stand height

Aluminium parts: RAL 9016 traffic white

Max. load capacity of the support arm: 18 kg

Product weight: 1 Kg

Product Highlights:

Provides full screen integration and easy cleaning for infection control in all critical care areas of the clinical environment. Our 5-year warranty ensures reliable, trouble-free and maintenance-free operation. The swivel function at the point of attachment as well as the tilt and swivel function of the monitor adaptation offer optimal positioning of your device.